

### Overview

#### HPE ProLiant DL345 Gen11

Are you looking for a single-socket scalable server solution to power your virtualized data-intensive, large-capacity storage workloads? The HPE ProLiant DL345 Gen11 server is a scalable 2U 1P solution that delivers exceptional compute performance and large capacity storage options at 1P economics. Powered by 4th Generation AMD EPYC™ Processors with up to 128 cores, increased memory bandwidth (up to 3 TB), high-speed PCIe Gen5 I/O and EDSFF storage, up to 20LFF/ 34SFF, and up to 4 GPUs at the front, this server is a superb single-socket 2U solution for your data-intensive workloads. Enhanced security features with the HPE silicon root of trust are built into the firmware, creating a digital fingerprint for the AMD Secure Processor to validate safe operation before boot. The HPE DL345 Gen11 server provides impressive storage performance and options for data-intensive workloads like software-defined storage, video transcoding, and virtualized apps.



Front View - 24 SFF chassis shown

- |   |   |
|---|---|
| 1. Quick removal access panel                   | 7. Unit ID button/ LED                  |
| 2. Health LED                                   | 8. Box 3 - 8 SFF Drive Cage Bay         |
| 3. Power On/Standby button and system power LED | 9. Box 2 - 8 SFF Drive Cage Bay         |
| 4. iLO service port                             | 10. Box 1 - 8 SFF Drive Cage Bay        |
| 5. NIC status LED                               | 11. Serial number pull tab <sup>1</sup> |
| 6. USB 3.2 Gen1 Port                            |   |

**Notes:** <sup>1</sup>Optional: Universal Media Bay

Overview

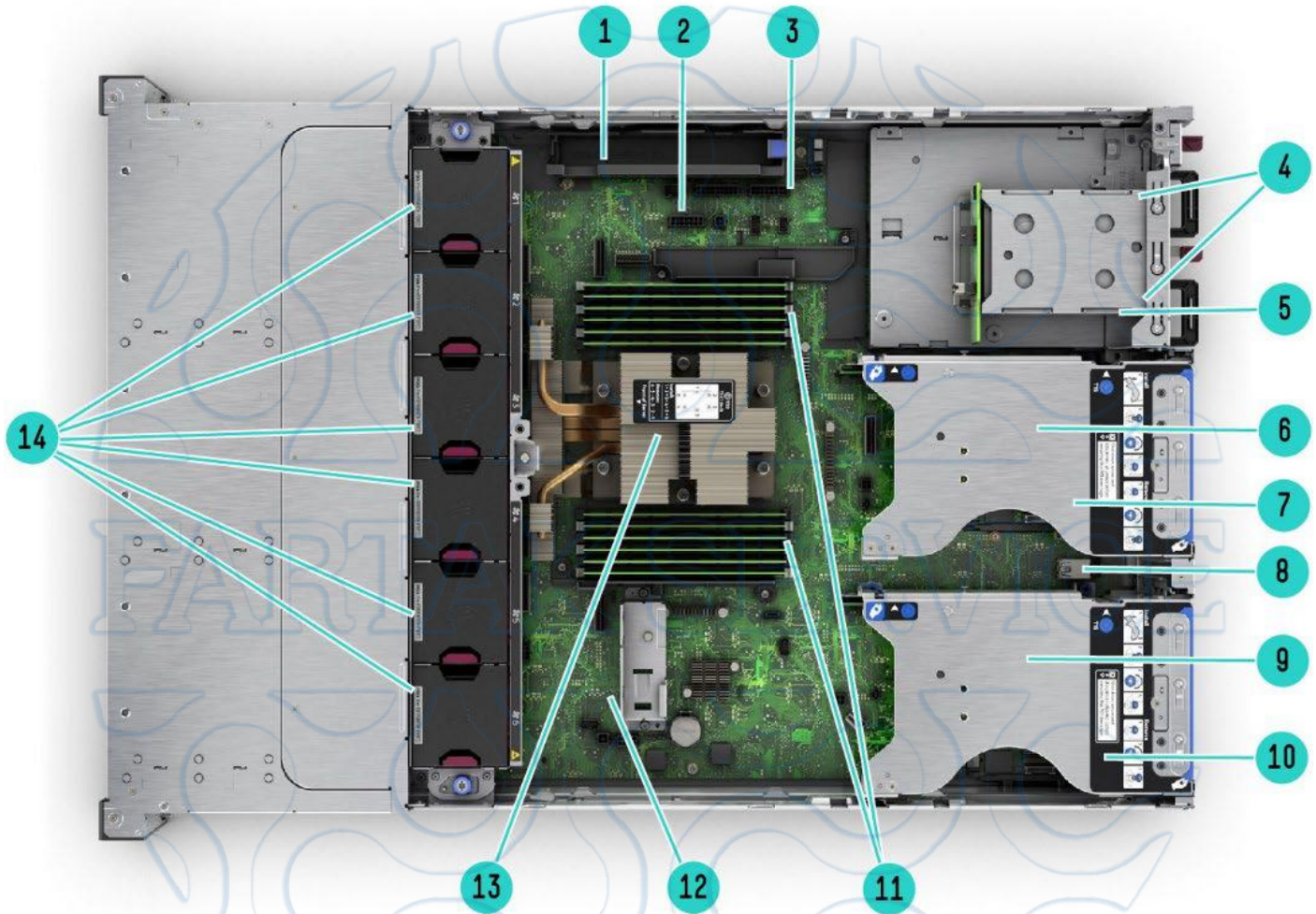

**Internal View – 2SFF rear cage shown**

- |  |  |
|--|--|
| 1. Megacell Battery holder   | 8. Internal Dual USB 3.2 Gen1 port                               |
| 2. Hard drive backplane power connectors                               | 9. Primary PCIe 5.0 risers, slot 1,2,3                           |
| 3. Chassis intrusion detection connector                               | 10. OCP 3.0 Slot 21 (Under)                                      |
| 4. Up to 2 Hot Plug redundant HPE Flexible Slot Power supplies (Under) | 11. DDR5 DIMM slots <sup>1</sup>                                 |
| 5. Rear 2 SFF Cage Bay (Optional)                                      | 12. FHFL PCIe card holder  |
| 6. Secondary PCIe 5.0 risers, slot 4,5,6                               | 13. Up to 1 Processor shown with standard heat sink <sup>2</sup> |
| 7. OCP 3.0 Slot 22 (Under)   | 14. Hot-plug fans <sup>3</sup>                                   |

**Notes:**

- <sup>1</sup>Fully populated 12 DIMMs shown
- <sup>2</sup>Optional: Performance Heat Sink
- <sup>3</sup>6 single-rotor standard fans shown. Optional: Performance Fans



## Overview

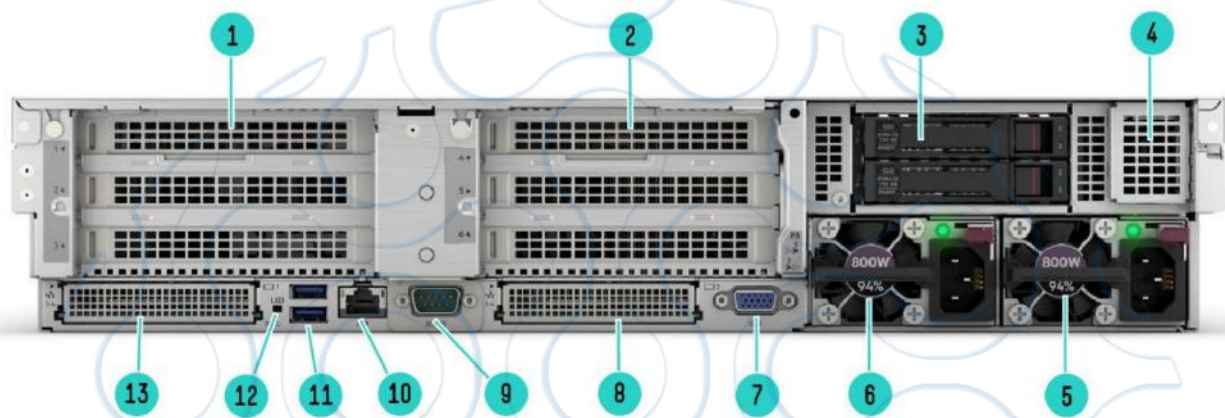

Rear View - 2SFF rear cage shown

- |  |                                   |
|--|-----------------------------------|
| 1. Primary PCIe 5.0 Riser <sup>1</sup>           | 8. OCP 3.0 slot 22                |
| 2. Secondary PCIe 5.0 Riser <sup>2</sup>         | 9. Optional Serial port           |
| 3. Optional Rear Drive Cage (2SFF SAS/SATA/NVMe) | 10. Dedicated iLO management port |
| 4. Optional NS204i-u hot-plug NVMe boot device   | 11. 2 USB 3.2 Gen1 port           |
| 5. Hot-plug Power Supply 1                       | 12. Unit ID LED                   |
| 6. Hot-plug Power Supply 2 (Optional)            | 13. OCP 3.0 slot 21               |
| 7. Video (VGA) port                              |                                   |

### Notes:

- <sup>1</sup>PCIe Slots 1,2,3 top to bottom.
- <sup>2</sup>PCIe Slots 4,5,6 top to bottom.

## What's New:

- All new DL345 Gen11
- New 4<sup>th</sup> Generation AMD EPYC™ Processors, up to 96 cores, 400W, and 384MB of L3 Cache.
- New DDR5 Smart Memory - 4800MT/s.
- New PCIe Gen5 support.
- New HPE Integrated Lights-Out 6 (iLO 6) server management software.
- New hot-pluggable NS204i-u Boot Device.
- New 4 LFF / 8 SFF Midtray and 4 LFF rear drive bay.
- New 36 EDSFF E3.S 1T drive bay.
- New GPU support, up to four single-width or two double-width GPUs.
- OpenBMC Capable through iLO6 Transfer of Ownership Process

## Platform Information

### Form Factor

- 2U rack

### Chassis Types

- 8 SFF with optional 16 SFF front bay, 8 SFF mid tray, and 2 SFF rear to a total of 34 SFF drives.
- 24 SFF with optional 8 SFF mid tray, and 2 SFF rear to total 34 SFF drives.
- 8 LFF with optional 4 LFF front bay, 4LFF mid tray, and 4LFF rear to a total of 20 LFF drives.
- 36 EDSFF E3.S 1T drive bay.
- 4 single-width or 2 double-width GPUs with 12 EDSFF or 8 SFF drive bay.



## Overview

### System Fans

- Choice of Standard Fan Kit and Performance Fan kit

#### Notes:

- The HPE DL345 Gen11 supports up to 6 fans with fan redundancy built in. One fan rotor failure will place the server in degraded mode but fully functional. Two fan rotor failures could provide a warning and imminent server shutdown.
  - Each Fan kit is designated to operate under different configurations. For more information, please refer to the Cooling option message in the Unique option section.
- 

FARTAK SERVICE



## Standard Features

**Processors** – One of the following depending on the model.

**Notes:** For more information regarding AMD EPYC processors, please see the following:

<https://www.amd.com/en/processors/epyc-9004-series>

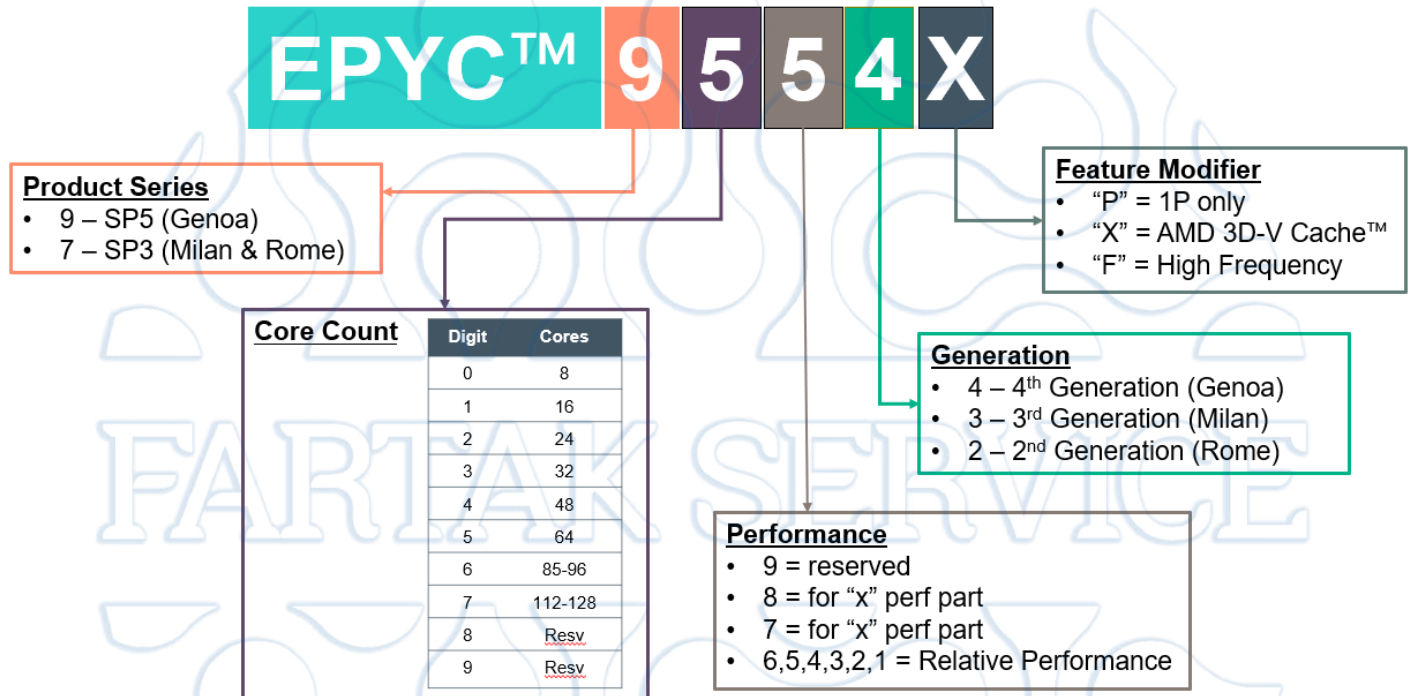

4 <sup>th</sup> Gen AMD EPYC Processor	Cores	Base Frequency	Max Frequency	Max Memory	Wattage	Cache	Memory
EPYC 9754	128	2.25 GHz	3.1 GHz	3TB	360	256	4800MT/s
EPYC 9734	112	2.2 GHz	3.0 GHz	3TB	340	256	4800MT/s
EPYC 9654P	96	2.4 GHz	3.7 GHz	3TB	360	384	4800MT/s
EPYC 9634	84	2.25 GHz	3.7 GHz	3TB	290	384	4800MT/s
EPYC 9554P	64	3.1 GHz	3.75 GHz	3TB	360	256	4800MT/s
EPYC 9534	64	2.45 GHz	3.7 GHz	3TB	280	256	4800MT/s
EPYC 9454P	48	2.75 GHz	3.8 GHz	3TB	290	256	4800MT/s
EPYC 9474F	48	3.6 GHz	4.1 GHz	3TB	360	256	4800MT/s
EPYC 9354P	32	3.25 GHz	3.8 GHz	3TB	280	256	4800MT/s
EPYC 9334	32	2.7 GHz	3.9 GHz	3TB	210	128	4800MT/s
EPYC 9374F	32	3.85 GHz	4.3 GHz	3TB	320	256	4800MT/s
EPYC 9254	24	2.9 GHz	4.15 GHz	3TB	200	128	4800MT/s
EPYC 9224	24	2.5 GHz	3.7 GHz	3TB	200	64	4800MT/s
EPYC 9274F	24	4.05 GHz	4.3 GHz	3TB	320	256	4800MT/s
EPYC 9124	16	3 GHz	3.7 GHz	3TB	200	64	4800MT/s
EPYC 9174F	16	4.1 GHz	4.4 GHz	3TB	320	256	4800MT/s
EPYC 9684X	96	2.55 GHz	3.7 GHz	3TB	400	1150	4800MT/s
EPYC 9384X	32	3.1 GHz	3.9 GHz	3TB	320	768	4800MT/s
EPYC 9184X	16	3.55 GHz	4.2 GHz	3TB	320	768	4800MT/s

**Notes:**

- 6096pin LGA SP5 new socket type.
- 1MB L2/Core, Up to 32MB L3/CCD
- All 4<sup>th</sup> generation AMD EPYC processors can support up to 3TB of memory each under 1DPC, 12 channels per processor.
- 128 PCIe 5.0 Lanes



## Standard Features

- 64 IO Lanes support CXL1.1+ with bifurcations supported down to x4
- The wattage information indicates the processor's default cTDP (Configurable TDP).

### Chipset

No chipset – System on Chip (SoC) design.

### On System Management Chipset

HPE iLO 6 ASIC

**Notes:** Read and learn more in the [iLO QuickSpecs](#)

### Memory

<b>Type</b>	HPE DDR5 Smart Memory Registered (RDIMM)
<b>DIMM Slots Available</b>	12 12 DIMM slots per processor, 12 channels per processor, 1 DIMM per channel
<b>Maximum capacity (RDIMM)</b>	3.0 TB 12 x 256 GB RDIMM @ 4800 MT/s at 1 DPC

#### Notes:

- All processors support up to 3TB of memory per server.
- LRDIMM and Persistent Memory are not supported.
- For additional information, please see the [HPE DDR5 Smart Memory QuickSpecs](#).
- For the Memory Population Rules and Guidelines with AMD EPYC 9004 series processors, see details here: <https://www.hpe.com/psnow/doc/a50007481enw>

### Memory Protection

#### Advanced ECC

Advanced ECC uses single-device data correction to detect and correct single and all multibit error that occurs within a single DRAM chip.

#### Online Spare

Memory online spare mode detects a rank that is degrading and switches operation to the spare rank.

**Notes:** For more information see our [Memory RAS feature technical whitepaper](#).

### Expansion Slots

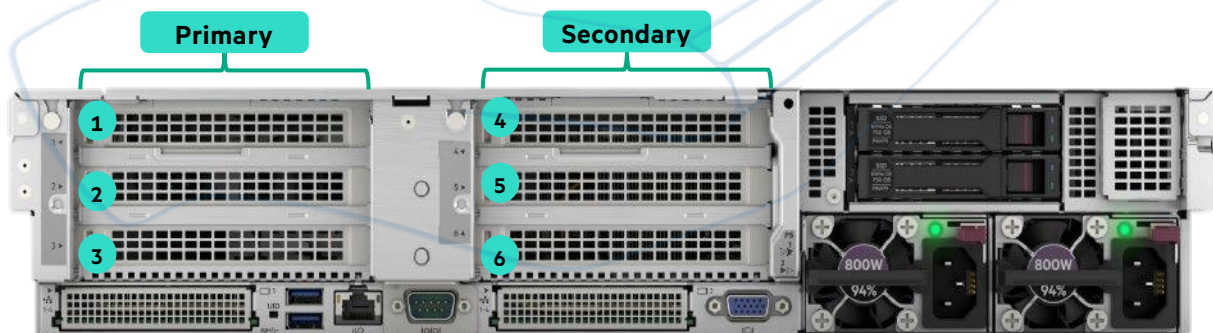

## Standard Features

### Default Two (2) PCIe Slots

Primary Riser				
Slots #	Technology	Bus Width	Connector Width	Slot Form Factor
3 (Default)	PCIe 5.0	X16	X16	Full-height, Half-length slot

Secondary Riser				
Slots #	Technology	Bus Width	Connector Width	Slot Form Factor
6 (Default)	PCIe 5.0	X16	X16	Full-height, Half-length slot

### Optional Four (4) Slots

Primary Riser				
Slots #	Technology	Bus Width	Connector Width	Slot Form Factor
1 (via Option Kit)	PCIe 5.0	X16	X16	Full-height, Half-length slot
2 (via Option Kit)	PCIe 5.0	X16	X16	Full-height, Half-length slot
3 (Default)	PCIe 5.0	X16	X16	Full-height, Half-length slot

Secondary Riser				
Slots #	Technology	Bus Width	Connector Width	Slot Form Factor
6 (Default)	PCIe 5.0	X16	X16	Full-height, Half-length slot

#### Notes:

- Requires 4PCIe enablement kit (P57116-B21) to support four (4) slots.
- When supporting Slot1 & OCP Slot22 scenario, Slot1 & OCP Slot22 combined can support up to 112GB/s bandwidth due to AMD CPU limitation.
- When supporting Slot2 & Slot3 scenario, Slot2 & Slot3 combined can support up to 112GB/s bandwidth due to AMD CPU limitation.

### Optional Six (6) slots

Primary Riser				
Slots #	Technology	Bus Width	Connector Width	Slot Form Factor
1 (via Option Kit)	PCIe 5.0	X16	X16	Full-height, Half-length slot
2 (via Option Kit)	PCIe 5.0	X16	X16	Full-height, Half-length slot
3 (Default)	PCIe 5.0	X16	X16	Full-height, Half-length slot

Secondary Riser				
Slots #	Technology	Bus Width	Connector Width	Slot Form Factor
4 (via Option Kit)	PCIe 5.0	X16	X16	Full-height, Half-length slot
5 (via Option Kit)	PCIe 5.0	X16	X16	Full-height, Half-length slot
6 (Default)	PCIe 5.0	X16	X16	Full-height, Half-length slot

#### Notes:

- Requires 6PCIe enablement kit (P57117-B21) to support six (6) PCIe slots
- When supporting Slot1 & Slot21 scenario, Slot1 & OCP Slot21 combined can support up to 112GB/s bandwidth due to AMD CPU limitation.
- When supporting Slot2 & Slot3 scenario, Slot2 & Slot3 combined can support up to 112GB/s bandwidth due to AMD CPU limitation.
- When supporting Slot4 & Slot22 scenario, Slot4 & OCP Slot22 combined can support up to 112GB/s bandwidth due to AMD CPU limitation.
- When supporting Slot5 & Slot6 scenario, Slot5 & Slot6 combined can support up to 112GB/s bandwidth due to AMD CPU limitation.



Standard Features

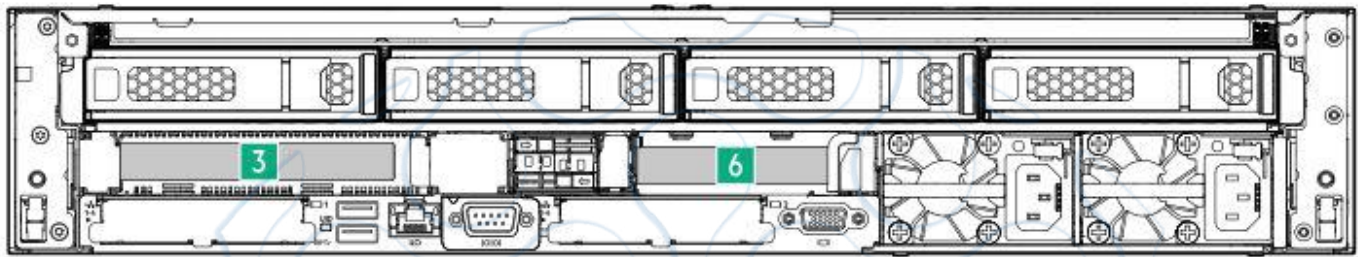

2 slots with 4 LFF rear drives

Primary Riser				
Slots #	Technology	Bus Width	Connector Width	Slot Form Factor
3 (Default)	PCIe 5.0	X16	X16	Full-height, Half-length slot

Secondary Riser				
Slots #	Technology	Bus Width	Connector Width	Slot Form Factor
6 (Option)	PCIe 5.0	X16	X16	Low Profile or Full-height, half-length slot

Notes:

- If the 4LFF rear drive bay is selected, then two (2) Primary riser kits (P55098-B21) OR a Primary riser kit (P55098-B21), a Low profile riser kit (P59260-B21), and an NS204i-u boot device (P48183-B21) must be selected.

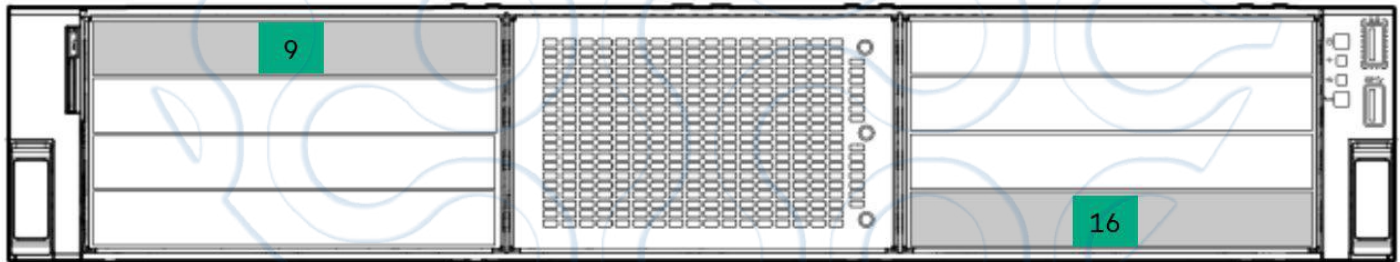

Front risers of GPU CTO server

Front Riser				
Slots #	Technology	Bus Width	Connector Width	Slot Form Factor
9	PCIe 5.0	X16	X16	Full-height, Full-length slot
16	PCIe 5.0	X16	X16	Full-height, Full-length slot

Notes:

- When supporting Slot9 & OCP Slot22 scenario, Slot9 & OCP Slot22 combined can support up to 112GB/s bandwidth due to AMD CPU limitation.
- When supporting Slot16 & OCP Slot21 scenario, Slot16 & OCP Slot21 combined can support up to 112GB/s bandwidth due to AMD CPU limitation.
- The extension slots at the front of the GPU CTO server do not support external cabling.



## Standard Features

### Storage Controllers

#### Boot Device

- HPE NS204i-u Gen11 NVMe Hot Plug Boot Optimized Storage Device

#### Notes:

- Includes Hot Plug capable dual 480GB NVMe M.2 automatically configured into a RAID 1 Mirror
- Externally accessible but does not occupy a PCIe slot
- Requires specific cable kit or secondary low-profile riser along with specific cooling selections based on configuration

#### Essential RAID Controller

- HPE Smart Array E208e-p SR Gen10 Controller

#### Tri-Mode Controller

- HPE MR216i-p Gen11 x16 Lanes without Cache PCI SPDM Plug-in Storage Controller
- HPE MR216i-o Gen11 x16 Lanes without Cache OCP SPDM Storage Controller
- HPE MR408i-o Gen11 x8 Lanes 4GB Cache OCP SPDM Storage Controller
- HPE MR416i-o Gen11 x16 Lanes 8GB Cache OCP SPDM Storage Controller
- HPE MR416i-p Gen11 x16 Lanes 8GB Cache PCI SPDM Plug-in Storage Controller
- HPE SR932i-p Gen11 x32 Lanes 8GB Wide Cache PCI SPDM Plug-in Storage

Notes: For additional details, please visit:

[HPE Compute MR Gen11 Controllers Quick Spec](#)

[HPE Compute SR Gen11 Controllers Quick Spec](#)

## Internal Storage Devices

### Optical Drive

- Available on 8SFF and 8LFF CTO Servers as an option (DVD-ROM or DVD-RW)

### Drives

- None ship standard

#### Maximum Internal Storage

	Capacity	Configuration
Hot Plug LFF SAS HDD	400 TB	20 x 20 TB
Hot Plug LFF SATA HDD	400 TB	20 x 20 TB
Hot Plug SFF SAS SSD	261.12 TB	34 x 7.68 TB
Hot Plug SFF SATA SSD	261.12 TB	34 x 7.68 TB
Hot Plug SFF NVMe PCIe U.3 SSD	522.24 TB	34 x 15.36 TB
Hot Plug EDSFF E3.S 1T NVMe SSD	552.96 TB	36 x 15.36 TB

## Interfaces

<b>Serial</b>	1 optional port - rear
<b>Video Port</b>	1 standard VGA Port - rear
<b>Network Ports</b>	None. Choice of OCP or stand-up card, supporting a wide arrange of NIC adapters BTO models will come pre-selected with a primary networking card.
<b>HPE iLO Remote Mgmt Port</b>	1 1Gb Dedicated - rear
<b>Front iLO Service Port</b>	1 standard
<b>USB 3.2 Gen1</b>	5 standard on all models: 1 front, 2 rear, 2 internal



## Standard Features

### Graphics

#### Integrated Video Standard

- Video modes up to 1920 x 1200@60Hz (32 bpp)
- 16MB Video Memory

---

#### HPE iLO 6 on system management memory

- 64 MB Flash
- 8 Gbit DDR 4 with ECC protection

---

### Power Supply

- HPE 500W Flex Slot Platinum Hot Plug Low Halogen Power Supply Kit  
**Notes: Available in 94% power Efficiency.**
- HPE 800W Flex Slot Platinum Hot Plug Low Halogen Power Supply Kit  
**Notes: Available in 94% Power Efficiency.**
- HPE 1000W Flex Slot Titanium Hot Plug Low Halogen Power Supply Kit  
**Notes: Available in 96% Power Efficiency.**
- HPE 1600W Flex Slot Platinum Hot Plug Low Halogen Power Supply Kit  
**Notes: Available in 94% Power Efficiency.**
- HPE 1600W Flex Slot -48VDC Hot Plug Power Supply Kit  
**Notes: Available in 94% Power Efficiency. 200-240VAC power input only.**
- HPE 1800W-2200W Flex Slot Titanium Hot Plug Power Supply Kit

HPE Flexible Slot (Flex Slot) Power Supplies share a common electrical and physical design that allows for hot plug, and tool-less installation into HPE ProLiant Servers. Flex Slot power supplies are certified for high-efficiency operation and offer multiple power output options, allowing users to "right-size" a power supply for specific server configurations. This flexibility helps to reduce power waste, lower overall energy costs, and avoid "trapped" power capacity in the data center.

All pre-configured servers ship with a standard 6-foot IEC C-13/C-14 jumper cord (A0K02A). This jumper cord is also included with each standard AC power supply option kit. If a different power cord is required, please check the [ProLiant Power Cables](#) web page.

To review the power requirements for your selected system, please use the [HPE Power Advisor Tool](#).

For information on power specifications and technical content visit [HPE Server power supplies](#).

---

### Operating Systems and Virtualization Software Support for ProLiant Servers

- [Windows Server 2019](#)
- [Windows Server 2022](#)
- [Red Hat Enterprise Linux \(RHEL\) 8.6](#)
- [Red Hat Enterprise Linux \(RHEL\) 9.0](#)
- [SUSE Linux Enterprise Server \(SLES\) 15 SP4](#)
- [VMware ESXi 7.0 U3](#)
- [VMware ESXi 8.0](#)

---

### Industry Standard Compliance

- ACPI 6.1 Compliant
- PCIe 5.0 Compliant
- WOL Support
- Microsoft® Logo certifications
- PXE Support
- VGA/Display Port



## Standard Features

- USB 3.2 Gen1 Compliant
- USB 2.0 Compliant
- Energy Star
- SMBIOS 3.1
- UEFI 2.7
- UEFI Class 3
- Redfish API
- IPMI 2.0
- Secure Digital 2.0
- Advanced Encryption Standard (AES)
- Triple Data Encryption Standard (3DES)
- SNMP v3
- TLS 1.2
- DMTF Systems Management Architecture for Server Hardware Command Line Protocol (SMASH CLP)
- Active Directory v1.0
- ASHRAE A3/A4

**Notes:** For additional technical thermal details regarding ambient temperatures, humidity, and features support please visit: [Extended Ambient Temperature Guidelines for HPE Gen11 servers](#)

- UEFI (Unified Extensible Firmware Interface Forum)
- APML 1.0

---

## Embedded Management

### HPE Integrated Lights-Out (HPE iLO)

Monitor your servers for ongoing management, service alerting, reporting, and remote management with HPE iLO.

Learn more at <http://www.hpe.com/info/iLO>.

### UEFI

Configure and boot your servers securely with industry-standard Unified Extensible Firmware Interface (UEFI).

### Intelligent Provisioning

Hassle-free server and OS provisioning for 1 or more servers with Intelligent Provisioning.

Learn more at [https://support.hpe.com/hpesc/public/docDisplay?docId=c04465280&docLocale=en\\_US](https://support.hpe.com/hpesc/public/docDisplay?docId=c04465280&docLocale=en_US)

### iLO RESTful API

iLO RESTful API is DMTF Redfish API implementation and offers simplified server management automation such as configuration and maintenance tasks based on modern industry standards. Learn more at <http://www.hpe.com/info/restfulapi>.

### OpenBMC Support

OpenBMC Capable through iLO6 Transfer of Ownership Process.

Learn more at [OpenBMC enablement on HPE ProLiant servers | HPE](#)

---



## Standard Features

### HPE Server UEFI

Unified Extensible Firmware Interface (UEFI) is an industry standard that provides better manageability and more secure configuration than the legacy ROM while interacting with your server at boot time. HPE ProLiant Gen11 servers have a UEFI Class 3 implementation.

#### UEFI enables numerous new capabilities specific to HPE ProLiant servers such as

- Secure Boot and Secure Start enable enhanced security
- Operating system specific functionality
- Support for > 2.2 TB (using GPT) boot drives
- USB 3.1 Gen1 Stack
- Embedded UEFI Shell
- Mass Configuration Deployment Tool using iLO RESTful API that is Redfish API Conformant
- PXE boot support for IPv6 networks
- Workload Profiles for simple performance optimization
- Embedded TPM Support

#### UEFI Boot Mode only

- NVMe Boot Support
- iSCSI Software Initiator Support.
- HTTP/HTTPS Boot support as a PXE alternative.
- Boot support for option cards that only support a UEFI option ROM

#### Notes:

- For UEFI Boot Mode, boot environment and OS image installation should be configured properly to support UEFI
- TPM is embedded on DL345 Gen11 mainboard and does not require additional option kit selection to enable this function.

---

## Server Utilities

### Active Health System

The HPE Active Health System (AHS) is an essential component of the iLO management portfolio that provides continuous, proactive health monitoring of HPE servers. Learn more at <http://www.hpe.com/servers/ahs>.

### Active System Health Viewing

The Active System Health Viewer (ASHV) is deprecated as of March 2022. Users are now recommended to use the InfoSight for Servers Portal for AHS viewing capabilities. In InfoSight for Servers portal, users will also be able to view hardware configuration details, firmware and driver information, warranty and support status of a server, wellness alerts, and create support cases for servers under a valid warranty or support contract.

HPE InfoSight provides the same security assurances as that of ASHV. Furthermore, InfoSight can be used as an ASHV replacement even if customers do not want to share ASHV logs and telemetry data on an ongoing basis

### Smart Update

Keep your servers up to date with the HPE Smart Update solution by using Smart Update Manager (SUM) to optimize the firmware and driver updates of the Service Pack for ProLiant (SPP). Learn more at

<https://www.hpe.com/us/en/servers/smart-update.html>

### iLO Amplifier Pack

Designed for large enterprise and service provider environments with hundreds of HPE servers, the iLO Amplifier Pack is a free, downloadable open virtual application (OVA) that delivers the power to discover, inventory, and update Gen8, Gen9, Gen10, and Gen10 Plus HPE servers. Use an iLO Advanced License to unlock full capabilities.

Learn more at <http://www.hpe.com/servers/iLOamplifierpack>.



## Standard Features

### RESTful Interface Tool

RESTful Interface tool (iLOREST) is a single scripting tool to provision using iLO RESTful API to discover and deploy servers at scale. Learn more at <http://www.hpe.com/info/resttool>.

### Scripting Tools

Provision one to many servers using your own scripts to discover and deploy with Scripting Tool (STK) for Windows and Linux or Scripting Tools for Windows PowerShell. Learn more at <http://www.hpe.com/servers/powershell>.

### HPE OneView Standard

HPE OneView is an on-premises, multi-generational server monitoring, and management solution. HPE OneView Standard can be used for inventory, health monitoring, alerting, and reporting without additional fees. Customers can upgrade their management experience with an HPE OneView Advanced license, all provided by the same tool. Learn more at <http://www.hpe.com/info/oneview>

### HPE GreenLake for Compute Ops Management

HPE is intelligently transforming compute management with an intuitive cloud operating experience through HPE GreenLake cloud platform to streamline and secure operations from edge-to-cloud. Automated key lifecycle tasks, for onboarding, updating, managing, and monitoring HPE servers, brings agility and greater efficiencies to wherever compute devices reside via a unified single browser-based interface. Manage single locations or multiple, distributed sites. Keep tens to thousands of servers secure with batch policy controls and automated updates.

Compute Ops Management is cloud-native software that is continually updated with new services, features, patches, and fixes. The management application resides in the HPE GreenLake cloud platform (access via <https://console.greenlake.hpe.com>) and leverages the HPE GreenLake architecture, security, and unified operations.

A 3-year subscription to HPE GreenLake for Compute Ops Management is added by default when ordering an HPE ProLiant Gen11 rack, tower, or micro server.

For more information, visit the HPE GreenLake for Compute Ops Management QuickSpecs:

<https://www.hpe.com/psnow/doc/a50004263enw>

---

## Security

- UEFI Secure Boot and Secure Start support
  - Immutable Silicon Root of Trust
  - FIPS 140-3 validation (iLO 6 certification in progress)
  - Common Criteria certification (iLO 6 certification in progress)
  - Configurable for PCI DSS compliance
  - Advanced Encryption Standard (AES) and Triple Data Encryption Standard (3DES) on browser
  - Support for Commercial National Security Algorithms (CNSA)
  - Tamper-free updates – components digitally signed and verified
  - Secure Recovery – recover critical firmware to known good state on detection of compromised firmware
  - Ability to rollback firmware
  - Secure erase of NAND/User data
  - TPM (Trusted Platform Module) 2.0 option
- Notes:** TPM is embedded on DL345 Gen11 mainboard and does not require additional option kit selection to enable this function.
- Bezel Locking Kit option
  - Chassis Intrusion detection option
- 



## Standard Features

### Server Management

#### HPE iLO Advanced

HPE iLO Advanced licenses offer smart remote functionality without compromise, for all HPE ProLiant servers. The license includes the fully integrated remote console, virtual keyboard, video, and mouse (KVM), multi-user collaboration, console record and replay, and GUI-based and scripted virtual media and virtual folders. You can also activate the enhanced security and power management functionality.

#### HPE OneView Advanced

HPE OneView Advanced offers a sophisticated level of automation to infrastructure management by taking a template driven approach to provisioning, updating, and integrating compute, storage, and networking infrastructure. It builds upon the base features of HPE OneView Standard and provides full-featured licenses which can be purchased for managing multiple HPE server generations. To learn more visit <http://www.hpe.com/info/oneview>.

#### HPE InfoSight for Servers

HPE InfoSight for Servers combines the cloud-based machine learning of InfoSight with the health and performance monitoring of Active Health System (AHS) and iLO to optimize performance and predict and prevent problems. The end result is an intelligent environment that modernizes IT operations and enhances the support experience by predicting and preventing the infrastructure issues that lead to application disruptions, wasted IT staff time, and missed business opportunities.

Learn more at <https://www.hpe.com/servers/infosight>

---

### Warranty

This product is covered by a global limited warranty and supported by HPE Services and a worldwide network of HPE Authorized Channel Partners resellers. Hardware diagnostic support and repair are available for three years from the date of purchase. Support for software and initial setup is available for 90 days from the date of purchase. Enhancements to warranty services are available through HPE Pointnext operational services or customized service agreements. Hard drives have either a one year or three year warranty; refer to the specific hard drive QuickSpecs for details.

**Notes:** Server Warranty includes 3-Year Parts, 3-Year Labor, and 3-Year Onsite support with next business day response. Warranty repairs may be accomplished through the use of Customer Self Repair (CSR) parts. These parts fall into two categories: 1) Mandatory CSR parts are designed for easy replacement. A travel and labor charge will result when customers decline to replace a Mandatory CSR part; 2) Optional CSR parts are also designed for easy replacement but may involve added complexity. Customers may choose to have Hewlett Packard Enterprise replace Optional CSR parts at no charge. Additional information regarding worldwide limited warranty and technical support is available at:

<https://www.hpe.com/us/en/search-results.html?page=1&q=servers%20warranty&autocomplete=0>

---

### Rack and Power Infrastructure

The story may end with servers, but it starts with the foundation that makes compute go – and business grow. We've reinvented our entire portfolio of rack and power products to make IT infrastructure more secure, more practical, and more efficient. In other words, we've created a stronger, smarter, and simpler infrastructure to help you get the most out of your IT equipment. As an industry leader, Hewlett Packard Enterprise is uniquely positioned to address the key concerns of power, cooling, cable management, and system access.

HPE G2 Advanced and Enterprise Racks are perfect for the server room or today's modern data center with the enhanced airflow and thermal management, flexible cable management, and a 10-year Warranty to support higher-density computing.

HPE G2 PDUs offer reliable power in flexible form factors that operate at temperatures up to 60°C, include color-coded outlets and load segments, and a low-profile design for optimal access to the rack and support for dense rack environments.

HPE Uninterruptible Power Systems are cost-effective power protection for any type of workload. Some UPSs include options for remote management and extended runtime modules so your critical dense data center is covered in power outages.

HPE KVM Solutions include a console and switches designed to work with your server and IT equipment reliably. We've got a cost-effective KVM switch for your first rack and multiple connection IP switches with remote management and security capabilities to keep your data center rack up and running.

Learn more about HPE Racks, KVM, PDUs, and UPSs at [HPE Rack and Power Infrastructure](#).



## Standard Features

### One Config Simple (OCS/SCE)

OCS/SCE is a guided self-service tool to help sales and non-technical people provide customers with initial configurations in 3 to 5 minutes. You may then send the configuration on for configuration help, or use it in your existing ordering processes. If you require "custom" rack configuration or configuration for products not available in SCE, please contact Hewlett Packard Enterprise Customer Business Center or an Authorized Partner for assistance. <https://h22174.www2.hpe.com/SimplifiedConfig/Welcome>

---

FARTAK SERVICE



## Service and Support

### HPE Pointnext - Service and Support

No matter where you are in your digital transformation journey, you can count on HPE Pointnext Services to provide the expertise you need, when and where you need it.

#### Advisory and Professional Services

Our Digital Next Advisory approach can help you identify, prioritize, and implement the right transformation initiatives to create new edge experiences, get real-time insights from all your data, and modernize your IT to enable new opportunities.

#### Operational Services

Take your IT operations to the next level with expertise and tools that can help save your staff time, manage complexity, and identify new ways to drive efficiency and effectiveness in your IT.

#### HPE Pointnext Tech Care

HPE Pointnext Tech Care is the new operational service experience for HPE products. Tech Care goes beyond traditional support by providing access to product specific experts, an AI driven digital experience, and general technical guidance to not only reduce risk but constantly search for ways to do things better. HPE Pointnext Tech Care has been reimagined from the ground up to support a customer-centric, AI driven, and digitally enabled customer experience to move your business forward. HPE Pointnext Tech Care is available in three response levels. Basic, which provides 9x5 business hour availability and a 2-hour response time. Essential which provides a 15-minute response time 24x7 for most enterprise level customers, and Critical which includes a 6-hour repair commitment where available and outage management response for severity 1 incidents.

<https://www.hpe.com/services/techcare>

#### HPE Pointnext Complete Care

HPE Pointnext Complete Care is a modular, edge-to-cloud IT environment service that provides a holistic approach to optimizing your entire IT environment and achieving agreed upon IT outcomes and business goals through a personalized and customer-centric experience. All are delivered by an assigned team of HPE Pointnext Services experts. HPE Pointnext Complete Care provides:

- A complete coverage approach -- edge to cloud
- An assigned HPE team
- Modular and fully personalized engagement
- Enhanced Incident Management experience with priority access
- Digitally enabled and AI driven customer experience

<https://www.hpe.com/services/completecure>

#### HPE Lifecycle Services

Lifecycle Services provide a variety of options to help maintain your HPE systems and solutions at all stages of the product lifecycle. A few popular examples include:

- Installation and Startup Services: Various levels for physical installation and power on, remote access setup, installation and startup, and enhanced installation services with the operating system.
- HPE Firmware Update Service: Recommendations for firmware revision levels for selected HPE products, taking into account the relevant revision dependencies within your IT environment.
- HPE Firmware Update Implementation Service: Implementation of firmware updates for selected HPE server, storage, and solution products, taking into account the relevant revision dependencies within your IT environment.
- HPE Implementation Assistance Service: Highly trained technical service specialists to assist you with a variety of activities, ranging from design, implementation, and platform deployment to consolidation, migration, project management, and onsite technical forums.
- HPE Service Credits: Access to prepaid services for flexibility to choose from a variety of specialized service activities, including assessments, performance maintenance reviews, firmware management, professional services, and operational best practices.
  - For a list of the most frequently purchased services using service credits, see the [Universal Service Credits Menu](#)



## Service and Support

### Parts and Materials

Hewlett Packard Enterprise will provide HPE-supported replacement parts and materials necessary to maintain the covered hardware product in operating condition, including parts and materials for available and recommended engineering improvements.

Parts and components that have reached their maximum supported lifetime and/or the maximum usage limitations as set forth in the manufacturer's operating manual, product QuickSpecs, or the technical product data sheet will not be provided, repaired, or replaced as part of these services.

The defective media retention service feature option applies only to Disk or eligible SSD/Flash Drives replaced by Hewlett Packard Enterprise due to malfunction.

---

### Consume IT on your terms

HPE Support Services are sold by Hewlett Packard Enterprise and Hewlett Packard Enterprise Authorized Service Partners:

- Services for customers purchasing from HPE or an enterprise reseller are quoted using HPE order configuration tools.
- Customers purchasing from a commercial reseller can find HPE Support Services at <https://ssc.hpe.com/portal/site/ssc/>

**HPE GreenLake** brings the cloud experience directly to your apps and data wherever they are—the edge, colocations, or your data center. It delivers cloud services for on-premises IT infrastructure specifically tailored to your most demanding workloads. With a pay-per-use, scalable, point-and-click self-service experience that is managed for you, HPE GreenLake accelerates digital transformation in a distributed, edge-to-cloud world.

- Get faster time to market
- Save on TCO, align costs to business
- Scale quickly, meet unpredictable demand
- Simplify IT operations across your data centers and clouds

### Managed services to run your IT operations

**HPE GreenLake Management Services** provide services that monitor, operate, and optimize your infrastructure and applications, delivered consistently and globally to give you unified control and let you focus on innovation.

---



## Pre-configured Models

Model	8 SFF	8 LFF
<b>SKU Number</b>	<b>P58792-B21</b> <b>P58792-291</b> <b>P58792-AA1</b>	<b>P58793-B21</b> <b>P58793-291</b> <b>P58793-AA1</b>
<b>Model Name</b>	HPE ProLiant DL345 Gen11 9124 3.0GHz 16-core 1P 32GB-R MR408i-o 8SFF 800W PS Server	HPE ProLiant DL345 Gen11 9124 3.0GHz 16-core 1P 32GB-R MR408i-o 8LFF 800W PS Server
<b>Processor</b>	9124 (16-Core, 3.0 GHz, 200W)	9124 (16-Core, 3.0 GHz, 200W)
<b>Number of Processors</b>	One processor	One processor
<b>Memory</b>	32 GB RDIMM SR 1Rx4 4800 MT/s (1x 32 GB)	32 GB RDIMM SR 1Rx4 4800 MT/s (1x 32 GB)
<b>Network Controller</b>	HPE 1GbE 4-port Base-T OCP3 Adapter plus a choice of OCP or standup card	HPE 1GbE 4-port Base-T OCP3 Adapter plus a choice of OCP or standup card
<b>Storage Controller</b>	HPE MR408i-o Gen11 x8 Lanes 4GB Cache OCP SPDM Storage Controller	HPE MR408i-o Gen11 x8 Lanes 4GB Cache OCP SPDM Storage Controller
<b>Drive</b>	None ship as standard	None ship as standard
<b>Internal Storage</b>	8 SFF Chassis (upgradeable to 16 SFF front)	8 LFF Chassis (upgradeable to 12 LFF front)
<b>Optical Drive</b>	None ship as standard	None ship as standard
<b>PCI-Express Slots</b>	2 PCIe x16 Riser (Primary slot 3 and Secondary slot 6)	2 PCIe x16 Riser (Primary slot 3 and Secondary slot 6)
<b>Power Supply</b>	1x 800W HPE FlexSlot Power Supply	1x 800W HPE FlexSlot Power Supply
<b>Fans</b>	6-standard fans	6-standard fans
<b>Management</b>	Default: HPE iLO Standard with Intelligent Provisioning, HPE OneView Standard (requires download)	Default: HPE iLO Standard with Intelligent Provisioning, HPE OneView Standard (requires download)
<b>Energy Star</b>	3.0 certified	3.0 certified
<b>Form Factor</b>	2U Rack	2U Rack
<b>Warranty</b>	3-year parts, 3-year labor, 3-year onsite support with next business day response.	3-year parts, 3-year labor, 3-year onsite support with next business day response.



## Pre-configured Models

Model	8 SFF	8 LFF
<b>SKU Number</b>	<b>P58792-421</b>	<b>P58793-421</b>
<b>Model Name</b>	HPE ProLiant DL345 Gen11 9124 3.0GHz 16-core 1P 32GB-R MR408i-o 8SFF 1000W PS EU Server	HPE ProLiant DL345 Gen11 9124 3.0GHz 16-core 1P 32GB-R MR408i-o 8LFF 1000W PS EU Server
<b>Processor</b>	9124 (16-Core, 3.0 GHz, 200W)	9124 (16-Core, 3.0 GHz, 200W)
<b>Number of Processors</b>	One processor	One processor
<b>Memory</b>	32 GB RDIMM DR 2Rx8 4800 MT/s (1x 32 GB)	32 GB RDIMM DR 2Rx8 4800 MT/s (1x 32 GB)
<b>Network Controller</b>	HPE 1GbE 4-port Base-T OCP3 Adapter plus choice of OCP or standup card	HPE 1GbE 4-port Base-T OCP3 Adapter plus choice of OCP or standup card
<b>Storage Controller</b>	HPE MR408i-o Gen11 x8 Lanes 4GB Cache OCP SPDM Storage Controller	HPE MR408i-o Gen11 x8 Lanes 4GB Cache OCP SPDM Storage Controller
<b>Drive</b>	None ship as standard	None ship as standard
<b>Internal Storage</b>	8 SFF Chassis (upgradeable to 16 SFF front)	8 LFF Chassis (upgradeable to 12 LFF front)
<b>Optical Drive</b>	None ship as standard	None ship as standard
<b>PCI-Express Slots</b>	2 PCIe x16 Riser (Primary slot 3 and Secondary slot 6)	2 PCIe x16 Riser (Primary slot 3 and Secondary slot 6)
<b>Power Supply</b>	1x 1000W HPE FlexSlot Power Supply <b>Notes: EU Lot-9 compliant.</b>	1x 1000W HPE FlexSlot Power Supply <b>Notes: EU Lot-9 compliant.</b>
<b>Fans</b>	6-standard fans	6-standard fans
<b>Management</b>	Default: HPE iLO Standard with Intelligent Provisioning, HPE OneView Standard (requires download)	Default: HPE iLO Standard with Intelligent Provisioning, HPE OneView Standard (requires download)
<b>Energy Star</b>	3.0 certified	3.0 certified
<b>Form Factor</b>	2U Rack	2U Rack
<b>Warranty</b>	3-year parts, 3-year labor, 3-year onsite support with next business day response.	3-year parts, 3-year labor, 3-year onsite support with next business day response.

## Country Code Key

xx1 = B21 Worldwide

xx1 = 291 Japan

xx1 = 421 EMEA

xx1 = AA1 China



## Configuration Information

### Smart Templates from HPE

HPE is releasing new Smart Template technology in the One Config Advanced (OCA) configurator. These Templates represent the CTO equivalents of the top-selling BTO configurations. They are intended to provide simple starting points to assist you in easily creating and customizing your desired Server solutions. HPE Servers that have Platform Templates, developed by HPE Product Managers, will have a separate tab in the HPE OCA configurator.

### Workload Solutions Templates from HPE

The Workload Solutions Templates build on the Smart Templates technology to easily develop working configurations of the most compelling Workload Solutions. The templates complement the Reference Builds developed by HPE. Workload Solutions templates preconfigure some of the key architecture decisions and make it easier for Sellers to get started and complete a differentiated server solution for your customer's specific workload.

### Mainstream SKUs

HPE launched the Mainstream SKU initiative as a market-driven approach to Demand Steering. It is a simplified portfolio of our top selling options that meet the current and future market trends. HPE has committed to providing a more predictable and faster experience for these options. Mainstream SKUs enjoy higher safety stock levels and have high fulfillment service levels than non-Mainstream SKUs. Mainstream orders are fulfilled +30% faster than non-Mainstream orders, have fewer shortages, and better recovery dates. This platform has Mainstream SKUs in the options portfolio and is eligible for an improved Mainstream experience. Mainstream SKUs are designated with a Mainstream symbol in our configurators.

### Mainstream Configurations

HPE is using the new Smart Templates technology to present Mainstream configurations. All the options in a Mainstream configuration are pre-selected Mainstream SKUs to optimize the performance, predictability, and fulfillment experience. Check the Template section in our configurators for eligible Mainstream configurations.

### European Union Erp Lot 9 Regulation

Beginning on January 1st, 2024, units sold into the European Union (EU), European Economic Area (EEA), the United Kingdom, or Switzerland must include more efficient AC power supplies: 94% for multi-output and 96% for single-output. HPE Flexible Slot power supplies are single-output, and part numbers 865438-B21, P03178-B21, and P44712-B21 are 96% efficient, thus meeting requirements.

HPE is on target to fulfil compliant systems ahead of time and will begin enforcing these requirements in advance to satisfy requests with the current power supplies by the set deadline.

---

This section lists some of the steps required to configure a Factory Integrated Model. To ensure only valid configurations are ordered, Hewlett Packard Enterprise recommends the use of an HPE approved configurator. Contact your local sales representative for information on configurable product offerings and requirements.

- Factory Integrated Models must start with a CTO Server.
- FIO indicates that this option is only available as a factory installable option.
- All Factory Integrated Models will be populated with sufficient hard drive blanks based on the number of initial hard drives ordered with the server.
- Some options may not be integrated at the factory. Contact your local sales representative for additional information.



## Configuration Information

**Step 1: Base Configuration** (choose one (1) of the following configurable models from the tables below)

CTO Server	HPE ProLiant DL345 Gen11 8LFF Configure-to-order Server	HPE ProLiant DL345 Gen11 8SFF Configure-to-order Server	HPE ProLiant DL345 Gen11 24SFF Configure-to-order Server	HPE ProLiant DL345 Gen11 EDFF Configure-to-order Server	HPE ProLiant DL345 Gen11 GPU Configure-to-order Server
<b>SKU Number</b>	P54204-B21	P54205-B21	P54206-B21	P54207-B21	P54208-B21
<b>TAA SKU</b>	P54204-B21#GTA	P54205-B21#GTA	P54206-B21#GTA	P54207-B21#GTA	P54208-B21#GTA
<b>HPE Trusted Supply Chain</b>	P36394-B21 – Optional				
<b>Processor</b>	Not included as standard				
<b>DIMM Slots</b>	12-DIMM slots				
<b>Storage Controller</b>	Choice of HPE Smart Array controllers			Not Supported	
<b>PCIe</b>	2 PCIe x16 Riser (Primary slot 3 and Secondary slot 6)				
<b>OCP3.0 slot</b>	2 PCIe 5.0 x8				
<b>Drive Cage – included</b>	8 LFF	Not included	3 8SFF x1	Not included	Not included
<b>Network Controller</b>	Choice of either OCP 3.0 or select stand-up network adapters for primary networking selection plus additional/optional stand-up network adapters <b>Notes: No embedded networking</b>				
<b>Cooling</b>	Choice of Standard or Performance Heat Sink Choice of Standard or Performance Fan Kit				
<b>Management</b>	Default: HPE iLO Standard with Intelligent Provisioning, HPE OneView Standard (requires download), HPE GreenLake for Compute Ops Management (subscription included)				
<b>Video</b>	1 VGA rear				
<b>USB</b>	Front: 1 USB 3.2 Gen1 + iLO service port Rear: 2 USB 3.2 Gen1 Internal: 2 USB 3.2 Gen1				
<b>Security</b>	TPM2.0 (Trusted Platform Module) embedded <b>Notes: Disabled on shipments to China</b>				
<b>Rail Kit</b>	Optional Easy Install rails and CMA				
<b>Form Factor</b>	2U Rack				
<b>Warranty</b>	3-year parts, 3-year labor, 3-year onsite support with next business day response.				

### Notes:

- HPE offers multiple Trade Agreement Act (TAA) compliant configurations to meet the needs of US Federal Government customers. These products are either manufactured or substantially transformed in a designated country. TAA compliance is only provided when HPE options are included as part of factory integrated orders (CTO).
- TAA compliant configuration requires TAA versions of the CTO Server SKUs.
- HPE Trusted Supply Chain (P36394-B21) is an optional security upgrade intended for agencies and regulated industries needing enhanced security and compliance needs. Applying this option to a DL325 Gen11 CTO server ensures it is built in the USA in a secured facility by vetted HPE personnel assigned to the manufacturing processes. A multitude of checkpoints/inspections for malicious microcode and counterfeit parts are performed throughout the server build, and additional safeguards are put in place against cyber-exploits throughout the server lifecycle. See “HPE Security” section within this document for more detail and learn more at <http://www.hpe.com/security>
- All CTO servers are Energy Star 3.0 compliant.



## Configuration Information

CTO Server	8 LFF CTO server	8 SFF CTO server	24 SFF CTO server	EDSFF CTO server	GPU CTO server
<b>Included Drive Cage</b>	8 LFF (2x 4LFF Drive cages)	Not included	3x 8 SFF U.3 x1 Drive Cage	Not included	Not included
<b>Universal Media Bay</b>	1 Optional	1 Optional	Not available	Not available	Not available
<b>ODD</b>	1 Optional	1 Optional	Not available	Not available	Not available
<b>8 SFF SAS/SATA/NVMe (Front)</b>	Not available	3 Optional	Not available	Not available	1 Optional
<b>8 SFF SAS/SATA/NVMe (Mid Tray)</b>	Not available	1 Optional	1 Optional	Not available	Not available
<b>2 SFF SAS/SATA/NVMe (Front)</b>	1 Optional	1 Optional	Not available	Not available	Not available
<b>2 SFF SAS/SATA/NVMe (Rear)</b>	1 Optional	1 Optional	1 Optional	Not available	Not available
<b>4 LFF SAS/SATA</b>	1 Optional	Not available	Not available	Not available	Not available
<b>4 LFF Mid Tray</b>	1 Optional	Not available	Not available	Not available	Not available
<b>4 LFF Rear</b>	1 Optional	Not available	Not available	Not available	Not available
<b>12 EDSFF NVMe (Front)</b>	Not available	Not available	Not available	3 Optional	1 Optional

### Notes:

- This applies to CTO configurations; field upgrades may differ depending on field configuration.
- Drive cage kits need to be ordered separately for the 8SFF CTO server, EDSFF CTO server and GPU CTO server.

## Step 2: Choose Core Options

- Choice of 1 Processor model and Heat Sink Kit
  - Requires necessary Heat Sink for different processor wattage.
- Choice of DDR5 memory options.
  - Requires necessary Fan Kits for different memory configurations and subjects to the recommended system ambient temperature.
- Choice of Drive cage, Storage Controllers, and Storage Controller Cables
- Choice of SSD, HDD, and Optical Drives
- Choice of OS Boot Devices
- Choice of Riser Cards
- Choice of Networking options
  - PCIe standup or OCP 3.0. Requires necessary Fan Kits and subjects to the recommended system ambient temperature.
- Choice of Accelerator options
- Choice of Power and Cooling options
- Choice of Security options
- Choice of Software as a Service Management - HPE GreenLake for Compute Ops Management and HPE OneView

## Step 3: Choose Additional Options

- Choice of Embedded Management
- Choice of Rail Kits
- Choice of Rack options
- Choice of Support Services



## Core Options

### Choice of Core Options

#### Processor

Please select ONE 4<sup>th</sup> Generation AMD EPYC Processor

AMD EPYC 9124 3.0GHz 16-core 200W Processor for HPE	P53702-B21
AMD EPYC 9174F 4.1GHz 16-core 320W Processor for HPE	P53698-B21
AMD EPYC 9224 2.5GHz 24-core 200W Processor for HPE	P58540-B21
AMD EPYC 9254 2.9GHz 24-core 200W Processor for HPE	P53707-B21
AMD EPYC 9274F 4.05GHz 24-core 320W Processor for HPE	P53711-B21
AMD EPYC 9334 2.7GHz 32-core 210W Processor for HPE	P53712-B21
AMD EPYC 9354P 3.25GHz 32-core 280W Processor for HPE	P53704-B21
AMD EPYC 9374F 3.85GHz 32-core 320W Processor for HPE	P53710-B21
AMD EPYC 9454P 2.75GHz 48-core 290W Processor for HPE	P53709-B21
AMD EPYC 9474F 3.6GHz 48-core 360W Processor for HPE	P53706-B21
AMD EPYC 9534 2.45GHz 64-core 280W Processor for HPE	P53699-B21
AMD EPYC 9554P 3.1GHz 64-core 360W Processor for HPE	P53703-B21
AMD EPYC 9634 2.25GHz 84-core 290W Processor for HPE	P53705-B21
AMD EPYC 9654P 2.4GHz 96-core 360W Processor for HPE	P53697-B21
AMD EPYC 9734 2.2GHz 112-core 340W Processor for HPE	P60465-B21
AMD EPYC 9754 2.25GHz 128-core 360W Processor for HPE	P60463-B21
AMD EPYC 9684X 2.55GHz 96-core 400W Processor for HPE	P63493-B21
AMD EPYC 9384X 3.1GHz 32-core 320W Processor for HPE	P63492-B21
AMD EPYC 9184X 3.55GHz 16-core 320W Processor for HPE	P63491-B21

#### Notes:

- Processors upto 240W require Standard Heat Sink (P58458-B21) and Standard Fan Kit (P58464-B21).
- Processors more than or equal to 260W require Performance Heat Sink (P58459-B21) and Performance Fan Kit (P58465-B21).
- If processor less than or equal to 300W is selected along 4LFF or 8SFF mid tray drive cage, then 1U Performance Heat Sink (P58457-B21) and Performance Fan Kits (P58465-B21) must be selected.

#### Memory

Please select one or more memory from below.

For new DDR5 memory, please go to **[HPE DDR5 Smart Memory QuickSpecs](#)**

For details on the Memory Population Rules and Guidelines with AMD EPYC 9004 series processors, please go to: **<https://www.hpe.com/psnow/doc/a50007481enw>**

#### Notes:

- Quantity of memory DIMMs selected per socket must be 1, 2, 4, 6, 8, 10, or 12.
- The maximum memory speed and capacity is a function of the memory type, memory configuration, and processor model.
- HPE Server Memory compatibility for a specific server platform may vary or be limited within a server platform depending upon the specific configuration being requested. Because each server environment and requirements can vary, memory compatibility is based not only upon the server family but may also be affected by the amount and type of additional hardware options installed within a specific server configuration. For this reason, some HPE memory DIMMs may be qualified for an HPE server model or family and yet occasionally not be supported with some configurations within that server family.



## Core Options

### Registered DIMMs (RDIMMs)

HPE 16GB (1x16GB) Single Rank x8 DDR5-4800 CAS-40-39-39 EC8 Registered Smart Memory Kit	P50309-B21
HPE 32GB (1x32GB) Single Rank x4 DDR5-4800 CAS-40-39-39 EC8 Registered Smart Memory Kit	P50310-B21
HPE 32GB (1x32GB) Dual Rank x8 DDR5-4800 CAS-40-39-39 EC8 Registered Smart Memory Kit	P50311-B21
HPE 64GB (1x64GB) Dual Rank x4 DDR5-4800 CAS-40-39-39 EC8 Registered Smart Memory Kit	P50312-B21
HPE 96GB (1x96GB) Dual Rank x4 DDR5-4800 EC8 Registered Smart Memory Kit	P66676-B21
HPE 128GB (1x128GB) Quad Rank x4 DDR5-4800 CAS-46-39-39 EC8 Registered 3DS Smart Memory Kit	P50313-B21
HPE 256GB (1x256GB) Octal Rank x4 DDR5-4800 CAS-46-39-39 EC8 Registered 3DS Smart Memory Kit	P50314-B21

### Notes:

- Mixing of x4 memory and x8 memory is not supported.
- Mixing of 3DS memory and non-3DS memory is not supported.
- Min= 12 for 96GB memory (P66676-B21)
- If 256GB memory is selected then "4LFF Midtray" OR "8SFF x1 Midtray" OR "8SFF x4 Midtray" cannot be selected.
- Supported cooling configuration of 256GB memory:

Front Drive Bay	Mid Tray	Fan Kits
12 LFF SAS/SATA	None	Perf Fan
16 SFF SAS/SATA/NVMe + media bay	None	Perf Fan
24 SFF SAS/SATA/NVMe	None	Perf Fan
20/24 EDSFF NVMe	None	Perf Fan
36 EDSFF NVMe	None	Perf Fan
24 SFF SAS/SATA/NVMe	8SFF	Not Support
12 LFF SAS/SATA	4LFF	Not Support

## Storage

### Drive cages

#### Notes:

- Mixing of 8SFF x4 backplane kit and 8SFF x1 backplane kit is not supported.
- Maximum one (1) 2SFF x4 U.3 BC Front/Tertiary Stackable Drive Cage Kit (P57110-B21) OR 2SFF x4 U.3 BC Side-by-Side Drive Cage Kit (P57111-B21) can be selected in the order.
- The type of drives that each drive cage supports is listed in the below table.

PN	Description	SATA	SAS	NVMe U.3 Static SSD	NVMe U.3 SSD	NVMe U.2 SSD
P55082-B21	HPE DL3x5 Gen11 8SFF TM U.3 x1 BC BP Kit	X	X	X	X	Not Support
P55083-B21	HPE DL3x5 Gen11 8SFF TM U.3 x4 BC BP Kit	X	X	X	X	Not Support
P57108-B21	HPE DL345 Gen11 8SFF x1 TM BC Mid Kit	X	X	X	X	Not Support
P57109-B21	HPE DL345 Gen11 8SFF x4 TM BC Mid Kit	X	X	X	X	Not Support
P57110-B21	HPE DL345 Gen11 2SFF x4 TM BC Kit	X	X	X	X	Not Support
P57111-B21	HPE DL345 Gen11 2SFF x4 TM BC Box1 Kit	X	X	X	X	Not Support
P57112-B21	HPE DL345 Gen11 4LFF x1 SAS/SATA Mid Kit	X	X	Not Support	Not Support	Not Support
P57113-B21	HPE DL345 Gen11 4LFF x1 SAS/SATA FIO Kit	X	X	Not Support	Not Support	Not Support
P57114-B21	HPE DL345 Gen11 4LFF x1 SAS/SATA BP Kit	X	X	Not Support	Not Support	Not Support
P57867-B21	HPE DL3x5 Gen11 GPU 8SFF U.3 Kit	X	X	X	X	Not Support



## Core Options

HPE ProLiant DL385 Gen11 8SFF Tri-Mode U.3 x1 BC Backplane Kit

P55082-B21

### Notes:

- Supports 8 SFF SAS/SATA/ NVMe (U.3) Basic Carrier (BC) Drives at the front.
- This drive cage can only be selected with the 8SFF CTO server (P54205-B21).
- Max = 2.
- Please select the 24SFF CTO server (P54206-B21) for three (3) 8SFF x1 U.3 drive cage configuration.
- If this Backplane kit is selected then one of the following cable options is supported:
  - o With PCIe controllers: 8SFF x1 Tri-Mode Box2/3 Primary Cable Kit (P57123-B21).
  - o SATA direct attach: 8SFF x1 NVMe/SATA Direct Attach Box2/3 Cable Kit (P57121-B21).

HPE ProLiant DL385 Gen11 8SFF Tri-Mode U.3 x4 BC Backplane Kit

P55083-B21

### Notes:

- Supports 8 SFF SAS/SATA/ NVMe (U.3) Basic Carrier (BC) Drives at the front.
- This drive cage can only be selected with the 8SFF CTO server (P54205-B21).
- Max = 3.
- If one or two of this Backplane kit is selected then one of the following cable options is supported:
  - o With PCIe controllers: 8SFF x4 Tri-Mode Box3 Primary Cable Kit (P57127-B21).
  - o Direct attach (x4 NVMe): 8SFF x4 NVMe Box3 Direct Attach Cable Kit (P57124-B21) and cannot select 4PCIE Enablement Kit (P57116-B21).
- if three (3) of this Backplane is selected then one of the following cable options is supported:
  - o Direct attach (x2 NVMe): 24SFF x2 NVMe Box1-3 Direct Attach Cable Kit (P57126-B21).
  - o Direct attach (x4 NVMe): Requires two (2) OCP retimers. Available in 1H'23.
  - o With PCIe controllers (x2 speed): 24SFF x2 Tri-Mode Box1-3 Cable Kit (P57129-B21).
  - o With PCIe controllers (x4 speed): 24SFF x4 Tri-Mode Box1-3 Primary/Secondary Cable Kit (P57128-B21).

HPE ProLiant DL345 Gen11 8SFF x4 U.3 NVMe Box 3 Direct Attach FIO Drive Cage Kit

P59255-B21

### Notes:

- Supports 8SFF NVMe x4 direct attach, including a 8SFF x4 U.3 backplane (P55083-B21) and a 8SFF x4 NVMe Box3 Direct Attach Cable Kit (P57124-B21).
- This drive cage can only be selected with the 8SFF CTO server (P54205-B21).
- Max = 1.
- This is a factory integrated only option.

HPE ProLiant DL345 Gen11 8SFF x1 Tri-Mode U.3 BC Mid Tray Drive Cage Kit

P57108-B21

### Notes:

- Supports 8 SFF SAS/SATA/ NVMe (U.3) Basic Carrier (BC) Drives at the Mid Tray.
- This drive cage can only be selected with the 24SFF CTO Server (P54206-B21).
- Max = 1.
- Requires processors less than or equal to 300W.
- Requires Performance Fan Kit (P58465-B21).

HPE ProLiant DL345 Gen11 8SFF x4 Tri-Mode U.3 BC Mid Tray Drive Cage Kit

P57109-B21

### Notes:

- Supports 8 SFF SAS/SATA/ NVMe (U.3) Basic Carrier (BC) Drives at the Mid Tray.
- This drive cage can only be selected with the 8SFF CTO server (P54205-B21).
- Max = 1.
- Requires processor less than or equal to 300W.
- Requires Performance Fan Kit (P58465-B21).



## Core Options

HPE ProLiant DL345 Gen11 2SFF x4 Tri-Mode U.3 BC Front/Tertiary Stackable Drive Cage Kit P57110-B21

### Notes:

- Supports 2 SFF of SAS/SATA/ NVMe (U.3) Basic Carrier (BC) Drives at the front or rear.
- Max = 1.
- If this drive cage is selected then 2SFF x4 U.3 BC Side-by-Side Drive Cage Kit (P57111-B21) and 4LFF x1 Rear Bay Backplane kit (P57113-B21) must not be selected.
- If the SFF media bay (P57857-B21) is selected then this 2SFF drive cage will be installed at the rear.
- Requires Performance Fan Kit (P58465-B21) if this 2SFF drive cage is at the rear.

HPE ProLiant DL345 Gen11 2SFF x4 Tri-Mode U.3 BC Side-by-Side Box 1 Drive Cage Kit P57111-B21

### Notes:

- Supports 2 SFF SAS/SATA/ NVMe (U.3) Basic Carrier (BC) Drives at the front.
- This drive cage can only be selected with the 8LFF CTO server (P54204-B21).
- Max = 1.
- If this drive cage is selected then 2SFF x4 U.3 BC Front/Tertiary Stackable Drive Cage Kit (P57110-B21) and 4LFF x1 Backplane kit (P57114-B21) must not be selected.

HPE ProLiant DL345 Gen11 4LFF x1 SAS/SATA 12G Front Backplane Kit P57114-B21

### Notes:

- Supports 4 LFF SAS/SATA Basic Carrier (BC) Drives at the front.
- This drive cage can only be selected with the 8LFF CTO server (P54204-B21).
- Max = 1.
- If this drive cage is selected then 2SFF x4 U.3 BC Side-by-Side Drive Cage Kit (P57111-B21) must not be selected.

HPE ProLiant DL345 Gen11 4LFF x1 SAS/SATA Mid Tray Drive Cage Kit P57112-B21

### Notes:

- Supports 4 LFF SAS/SATA Basic Carrier (BC) Drives at the Mid Tray.
- This drive cage can only be selected with the 8LFF CTO server (P54204-B21).
- Max = 1.
- Requires processor less than or equal to 300W.
- Requires Performance Fan Kit (P58465-B21) and 1U Performance Heat Sink (P58457-B21).

HPE ProLiant DL345 Gen11 4LFF x1 SAS/SATA Rear FIO Drive Cage Kit P57113-B21

### Notes:

- Supports 4 LFF SAS/SATA Basic Carrier (BC) Drives at the rear.
- This drive cage can only be selected with the 8LFF CTO server (P54204-B21).
- Max = 1.
- Requires Performance Fan Kit (P58465-B21).
- Requires 12LFF drive bay (P57114-B21).
- Maximum one (1) of 2SFF x4 U.3 BC Front/Tertiary Stackable Drive Cage Kit (P57110-B21) or 4LFF x1 Rear Bay Backplane kit (P57113-B21) is allowed.
- This is a factory integrated only option.

HPE ProLiant DL345 Gen11 36EDSFF x2 Box 1-3 Direct Attach FIO Drive Cage Kit P55090-B21

### Notes:

- Supports 36 EDSFF NVMe Drives in Box 1-3 at x2 speed
- This drive cage can only be selected with the EDSFF CTO server (P54207-B21).
- Max = 1.
- This is a factory integrated only option.
- No additional cable selection required.



## Core Options

HPE ProLiant DL345 Gen11 20EDSFF x4 Box 2-3 FIO Drive Cage Kit P64383-B21

### Notes:

- Supports 20 EDSFF NVMe Drives in Box 2-3 at x4 speed
- This drive cage can only be selected with the EDSFF CTO server (P54207-B21).
- Max = 1.
- This is a factory integrated only option.
- Bay #9-12 of box 2 is blocked from drive installation due to PCIe lane limitation.
- No additional cable selection required.

HPE ProLiant DL3X5 Gen11 GPU 8SFF U.3 FIO Backplane Kit P57867-B21

### Notes:

- Supports 8 SFF NVMe Basic Carrier (BC) Drives Direct Attach.
- This drive cage can only be selected with the GPU CTO server (P54208-B21).
- Max = 1.
- No additional cable selection required.

HPE ProLiant DL3X5 Gen11 GPU EDSFF FIO Backplane Kit P62355-B21

### Notes:

- Supports 12 EDSFF NVMe Drives Direct Attach.
- This drive cage can only be selected with the GPU CTO server (P54208-B21).
- Max = 1.
- Requires signal cable kit (P64381-B21) in the order

HPE ProLiant DL3X5 Gen11 SFF Universal Media Bay Kit P57857-B21

### Notes:

- This Universal Media Bay kit includes a cage, 2 USBs, and 1 DP port, and supports 1 Optical Drive.
- This media bay can only be selected with the 8SFF CTO server (P54205-B21).
- Max = 1.
- If the 8SFF CTO server (P54205-B21) and Optical Drives (701498-B21, 726536-B21, and 726537-B21) are selected then this Universal Media Bay Kit and ODD cable kit (P59602-B21) must be selected.
- This Media Bay kit cannot be selected with the preconfigured models (P58792-B21, P58793-B21).

## Storage Controller

The Gen11 storage controller portfolio has been updated to include new technology like OCP3.0 as well as PCIe adapters. For a more detailed breakout of the available Gen11 controllers visit the storage controllers QuickSpecs site:

[HPE Compute MR Gen11 Controllers Quick Spec](#)

[HPE Compute SR Gen11 Controllers Quick Spec](#)

### Notes:

- When selecting SR RAID controllers for external storage (E208e-p, 804398-B21) and MR RAID controllers for internal storage, please be aware these two products use different RAID configuration tools.
- Mixing of MR (MegaRAID) series controllers and SR (SmartRAID) series controllers is not allowed.

HPE Smart Array E208e-p SR Gen10 (8 External Lanes/No Cache) 12G SAS PCIe Plug-in Controller 804398-B21

### Notes:

- This controller supports up to 8 SAS/SATA Drives (external).
- Controller Based Encryption (CBE) with a remote key management server is not supported. Local key management(LKM) is supported.
- One Button Secure Erase (OBSE) used to sanitize drives and factory reset the controller is not supported.

HPE MR216i-o Gen11 x16 Lanes without Cache OCP SPDM Storage Controller P47789-B21

**Notes:** This controller supports up to 16 SAS/SATA/NVMe Drives.



## Core Options

HPE MR408i-o Gen11 x8 Lanes 4GB Cache OCP SPDM Storage Controller P58335-B21

**Notes:**

- This controller supports up to 8 SAS/SATA/NVMe Drives.
- Requires 96W Smart Stg Li-ion Batt 145mm Kit (P01366-B21) or Smart Hybrid Capacitor w/ 145mm Cbl (P02377-B21).

HPE MR416i-o Gen11 x16 Lanes 8GB Cache OCP SPDM Storage Controller P47781-B21

**Notes:**

- This controller supports up to 16 SAS/SATA/NVMe Drives.
- Requires 96W Smart Stg Li-ion Batt 145mm Kit (P01366-B21) or Smart Hybrid Capacitor w/ 145mm Cbl (P02377-B21).

HPE MR216i-p Gen11 x16 Lanes without Cache PCI SPDM Plug-in Storage Controller P47785-B21

**Notes:** This controller supports up to 16 SAS/SATA/NVMe Drives.

HPE MR416i-p Gen11 x16 Lanes 8GB Cache PCI SPDM Plug-in Storage Controller P47777-B21

**Notes:**

- This controller supports up to 16 SAS/SATA/NVMe Drives.
- Requires 96W Smart Stg Li-ion Batt 145mm Kit (P01366-B21) or Smart Hybrid Capacitor w/ 145mm Cbl (P02377-B21).

HPE SR932i-p Gen11 x32 Lanes 8GB Wide Cache PCI SPDM Plug-in Storage Controller P47184-B21

**Notes:**

- This controller supports up to 32 SAS/SATA/NVMe Drives.
- Requires 96W Smart Stg Li-ion Batt 145mm Kit (P01366-B21) or Smart Hybrid Capacitor w/ 145mm Cbl (P02377-B21).

## Battery and Hybrid Capacitor

HPE Smart Storage Hybrid Capacitor with 145mm Cable Kit P02377-B21

HPE 96W Smart Storage Lithium-ion Battery with 145mm Cable Kit P01366-B21

**Notes:** If HPE 96W Smart Stg Li-ion Batt 145mm Kit is selected then HPE Smart Hybrid Capacitor 145mm kit cannot be selected and vice versa.

## Storage Controller Cables

HPE ProLiant DL345 Gen11 8SFF x1 Box 2/3 Direct Attach Cable Kit P57121-B21

**Notes:** supports 8 SFF U.3 NVMe/SATA in box 2/3 direct attach with x1 speed.

HPE ProLiant DL345 Gen11 8SFF x1 SR932i-p Primary Box 1 Tri-Mode Cable Kit P57122-B21

**Notes:** supports 8 SFF U.3 SAS/SATA/NVMe in box1 connecting to SR932i-p controller with x1 speed.

HPE ProLiant DL345 Gen11 8SFF x1 Primary Box 2/3 Tri-Mode Cable Kit P57123-B21

**Notes:** supports 8 SFF U.3 SAS/SATA/NVMe in box 2/3 connecting to PCIe storage controllers with x1 speed.

HPE ProLiant DL345 Gen11 8SFF x4 NVMe Box 3 Direct Attach Cable Kit P57124-B21

**Notes:** supports 8 SFF U.3 NVMe in box3 direct attach with up to x4 speed.

HPE ProLiant DL345 Gen11 24SFF x2 NVMe Box 1-3 Direct Attach Cable Kit P57126-B21

**Notes:** supports 24 SFF U.3 NVMe in box 1-3 direct attach with x2 speed.

HPE ProLiant DL345 Gen11 8SFF x4 Primary Box 3 Tri-Mode Cable Kit P57127-B21

**Notes:** supports 8 SFF U.3 SAS/SATA/NVMe in box 3 connecting to PCIe storage controllers with up to x4 speed.



## Core Options

HPE ProLiant DL345 Gen11 24SFF x4 Box 1-3 Tri-Mode PCIe Cable Kit	P57128-B21
<b>Notes:</b> supports 24 SFF U.3 SAS/SATA/NVMe in box 1-3 connecting to PCIe storage controllers with up to x4 speed.	
HPE ProLiant DL345 Gen11 24SFF x2 Box 1-3 Tri-Mode Cable Kit	P57129-B21
<b>Notes:</b> supports 24 SFF U.3 SAS/SATA/NVMe in box 1-3 connecting with PCIe storage controllers with x2 speed.	
HPE ProLiant DL345 Gen11 8LFF x1 SAS/SATA Primary Cable Kit	P59254-B21
<b>Notes:</b> supports 8 LFF SAS/SATA in box 1-2 connecting to PCIe storage controllers.	
HPE ProLiant DL345 Gen11 12EDSFF x4 Direct Attach GPU Front Enablement Kit	P64381-B21
<b>Notes:</b>	
– Supports 12 EDSFF NVMe in GPU CTO server.	
– Must select together with 12EDSFF drive cage P62355-B21	

## HPE Drives

### Solid State Drives

For SSD selection guidance, please visit <https://ssd.hpe.com/>

#### Read Intensive - 12G SAS – SFF

HPE 960GB SAS 12G Read Intensive SFF BC Value SAS Multi Vendor SSD	P40506-B21
HPE 1.92TB SAS 12G Read Intensive SFF BC Value SAS Multi Vendor SSD	P40507-B21
HPE 3.84TB SAS 12G Read Intensive SFF BC Value SAS Multi Vendor SSD	P40508-B21
HPE 7.68TB SAS 12G Read Intensive SFF BC Value SAS Multi Vendor SSD	P40509-B21
HPE 1.92TB SAS 24G Read Intensive SFF BC Multi Vendor SSD	P49031-B21
HPE 3.84TB SAS 24G Read Intensive SFF BC Multi Vendor SSD	P49035-B21
HPE 7.68TB SAS 24G Read Intensive SFF BC Multi Vendor SSD	P49041-B21
HPE 15.36TB SAS 24G Read Intensive SFF BC Multi Vendor SSD	P49045-B21

#### Read Intensive - 12G SAS - LFF

HPE 7.68TB SAS 24G Read Intensive LFF LPC Multi Vendor SSD	P49040-B21
--	------------

#### Mixed Use - 12G SAS - SFF

HPE 960GB SAS 12G Mixed Use SFF BC Value SAS Multi Vendor SSD	P40510-B21
HPE 1.92TB SAS 12G Mixed Use SFF BC Value SAS Multi Vendor SSD	P40511-B21
HPE 3.84TB SAS 12G Mixed Use SFF BC Value SAS Multi Vendor SSD	P40512-B21
HPE 1.6TB SAS 24G Mixed Use SFF BC Multi Vendor SSD	P49049-B21
HPE 800GB SAS 24G Mixed Use SFF BC Multi Vendor SSD	P49047-B21
HPE 3.2TB SAS 24G Mixed Use SFF BC Multi Vendor SSD	P49053-B21
HPE 6.4TB SAS 24G Mixed Use SFF BC Multi Vendor SSD	P49057-B21
HPE 960GB SAS 24G Read Intensive SFF BC Multi Vendor SSD	P49029-B21

#### Mixed Use – 12G SAS– LFF

HPE 960GB SAS 12G Mixed Use LFF LPC Value SAS Multi Vendor SSD	P37009-B21
--	------------

#### Read Intensive - 6G SATA – SFF

HPE 240GB SATA 6G Read Intensive SFF BC Multi Vendor SSD	P40496-B21
HPE 480GB SATA 6G Read Intensive SFF BC Multi Vendor SSD	P40497-B21
HPE 960GB SATA 6G Read Intensive SFF BC Multi Vendor SSD	P40498-B21
HPE 1.92TB SATA 6G Read Intensive SFF BC Multi Vendor SSD	P40499-B21
HPE 3.84TB SATA 6G Read Intensive SFF BC Multi Vendor SSD	P40500-B21
HPE 7.68TB SATA 6G Read Intensive SFF BC Multi Vendor SSD	P40501-B21



## Core Options

HPE 480GB SATA 6G Read Intensive SFF BC PM893 SSD	P44007-B21
HPE 960GB SATA 6G Read Intensive SFF BC PM893 SSD	P44008-B21
HPE 1.92TB SATA 6G Read Intensive SFF BC PM893 SSD	P44009-B21
HPE 3.84TB SATA 6G Read Intensive SFF BC PM893 SSD	P44010-B21
<b>Mixed Use - 6G SATA - SFF</b>	
HPE 480GB SATA 6G Mixed Use SFF BC Multi Vendor SSD	P40502-B21
HPE 960GB SATA 6G Mixed Use SFF BC Multi Vendor SSD	P40503-B21
HPE 1.92TB SATA 6G Mixed Use SFF BC Multi Vendor SSD	P40504-B21
HPE 3.84TB SATA 6G Mixed Use SFF BC Multi Vendor SSD	P40505-B21
HPE 480GB SATA 6G Mixed Use SFF BC PM897 SSD	P44011-B21
HPE 960GB SATA 6G Mixed Use SFF BC PM897 SSD	P44012-B21
HPE 1.92TB SATA 6G Mixed Use SFF BC PM897 SSD	P44013-B21
<b>Very Read Optimized – 6G SATA – SFF</b>	
HPE 7.68TB SATA 6G Very Read Optimized SFF BC 5400 SSD	P58228-B21
<b>Read Intensive – 6G SATA – LFF</b>	
HPE 960GB SATA 6G Read Intensive LFF LPC Multi Vendor SSD	P47808-B21
<b>Very Read Optimized – 6G SATA – LFF</b>	
HPE 7.68TB SATA 6G Very Read Optimized LFF LPC 5400 SSD	P58232-B21
<b>Read Intensive - NVMe – SFF</b>	
HPE 1.92TB NVMe Gen4 High Performance Read Intensive SFF BC U.3 PM1733a SSD	P50216-B21
HPE 3.84TB NVMe Gen4 High Performance Read Intensive SFF BC U.3 PM1733a SSD	P50219-B21
HPE 7.68TB NVMe Gen4 High Performance Read Intensive SFF BC U.3 PM1733a SSD	P50222-B21
HPE 15.36TB NVMe Gen4 High Performance Read Intensive SFF BC U.3 PM1733a SSD	P50224-B21
HPE 960GB NVMe Gen4 Mainstream Performance Read Intensive SFF BC U.3 Static Multi Vendor SSD	P47844-B21
HPE 1.9TB NVMe Gen4 Mainstream Performance Read Intensive SFF BC U.3 Static Multi Vendor SSD	P47845-B21
HPE 3.84TB NVMe Gen4 Mainstream Performance Read Intensive SFF BC U.3 Static Multi Vendor SSD	P47846-B21
HPE 7.68TB NVMe Gen4 Mainstream Performance Read Intensive SFF BC U.3 Static Multi Vendor SSD	P47847-B21
<b>Mixed Use - NVMe – SFF</b>	
HPE 1.6TB NVMe Gen4 High Performance Mixed Use SFF BC U.3 PM1735a SSD	P50227-B21
HPE 3.2TB NVMe Gen4 High Performance Mixed Use SFF BC U.3 PM1735a SSD	P50230-B21
HPE 6.4TB NVMe Gen4 High Performance Mixed Use SFF BC U.3 PM1735a SSD	P50233-B21
HPE 800GB NVMe Gen4 Mainstream Performance Mixed Use SFF BC U.3 Static Multi Vendor SSD	P47837-B21
HPE 1.6TB NVMe Gen4 Mainstream Performance Mixed Use SFF BC U.3 Static Multi Vendor SSD	P47838-B21
HPE 3.2TB NVMe Gen4 Mainstream Performance Mixed Use SFF BC U.3 Static Multi Vendor SSD	P47839-B21
HPE 6.4TB NVMe Gen4 Mainstream Performance Mixed Use SFF BC U.3 Static Multi Vendor SSD	P47840-B21
<b>Read Intensive – NVMe - EDSFF E3.S 1T</b>	
HPE 3.84TB NVMe Gen5 High Performance Read Intensive E3S EC1 EDSFF PM1743 SSD	P57799-B21
HPE 7.68TB NVMe Gen5 High Performance Read Intensive E3S EC1 EDSFF PM1743 SSD	P57803-B21
HPE 15.36TB NVMe Gen5 High Performance Read Intensive E3S EC1 EDSFF PM1743 SSD	P57807-B21
<b>SED (Self-Encryption Drive) – SATA SFF</b>	
HPE 960GB SATA 6G Mixed Use SFF BC Self-encrypting 5400M SSD	P58244-B21
HPE 480GB SATA 6G Read Intensive SFF BC Self-encrypting 5400P SSD	P58236-B21
HPE 1.92TB SATA 6G Mixed Use SFF BC Self-encrypting 5400M SSD	P58248-B21
HPE 1.92TB SATA 6G Read Intensive SFF BC Self-encrypting 5400P SSD	P58240-B21



## Core Options

### SED (Self-Encryption Drive) – NVMe - SFF

HPE 1.6TB NVMe Gen4 High Performance Mixed Use SFF BC Self-encrypting FIPS U.3 CM6 SSD	P41404-B21
HPE 3.2TB NVMe Gen4 High Performance Mixed Use SFF BC Self-encrypting FIPS U.3 CM6 SSD	P41405-B21
HPE 1.92TB NVMe Gen4 High Performance Read Intensive SFF BC Self-encrypting FIPS U.3 CM6 SSD	P41402-B21
HPE 3.84TB NVMe Gen4 High Performance Read Intensive SFF BC Self-encrypting FIPS U.3 CM6 SSD	P41403-B21

**Notes:** If CM6 FIPS drive is selected then trimode controller must be selected.

### Hard Disk Drive

#### Enterprise - 12G SAS - SFF Drives

HPE 300GB SAS 12G Mission Critical 15K SFF BC 3-year Warranty Multi Vendor HDD	P28028-B21
HPE 2.4TB SAS 12G Mission Critical 10K SFF BC 3-year Warranty 512e Multi Vendor HDD	P28352-B21
HPE 1.2TB SAS 12G Mission Critical 10K SFF BC 3-year Warranty Multi Vendor HDD	P28586-B21
HPE 300GB SAS 12G Mission Critical 10K SFF BC 3-year Warranty Multi Vendor HDD	P40430-B21
HPE 900GB SAS 12G Mission Critical 15K SFF BC 3-year Warranty Multi Vendor HDD	P40432-B21
HPE 600GB SAS 12G Mission Critical 15K SFF BC 3-year Warranty Multi Vendor HDD	P53560-B21
HPE 600GB SAS 12G Mission Critical 10K SFF BC 3-year Warranty Multi Vendor HDD	P53561-B21
HPE 1.8TB SAS 12G Mission Critical 10K SFF BC 3-year Warranty 512e Multi Vendor HDD	P53562-B21

#### Midline - 12G SAS - SFF Drives

HPE 2TB SAS 12G Business Critical 7.2K SFF BC 1-year Warranty 512e HDD	P28505-B21
HPE 1TB SAS 12G Business Critical 7.2K SFF BC 1-year Warranty HDD	P53563-B21

#### Midline - 12G SAS - LFF Drives

HPE 12TB SAS 12G Business Critical 7.2K LFF LP 1-year Warranty Helium 512e Multi Vendor HDD	881781-B21
HPE 14TB SAS 12G Business Critical 7.2K LFF LP 1-year Warranty Helium 512e Multi Vendor HDD	P09155-B21
HPE 8TB SAS 12G Business Critical 7.2K LFF LP 1-year Warranty 512e Multi Vendor HDD	834031-B21
HPE 2TB SAS 12G Business Critical 7.2K LFF LP 1-year Warranty Multi Vendor HDD	833926-B21
HPE 4TB SAS 12G Business Critical 7.2K LFF LP 1-year Warranty Multi Vendor HDD	833928-B21
HPE 6TB SAS 12G Business Critical 7.2K LFF LP 1-year Warranty 512e Multi Vendor HDD	861746-B21
HPE 16TB SAS 12G Business Critical 7.2K LFF LP 1-year Warranty Helium 512e ISE Multi Vendor HDD	P23608-B21
HPE 18TB SAS 12G Business Critical 7.2K LFF LP 1-year Warranty Helium 512e ISE Multi Vendor HDD	P37669-B21
HPE 10TB SAS 12G Business Critical 7.2K LFF LP 1-year Warranty 512e ISE Multi Vendor HDD	P53556-B21
HPE 20TB SAS 12G Business Critical 7.2K LFF LP 1-year Warranty Helium 512e ISE Multi Vendor HDD	P53553-B21

#### Midline - 6G SATA - SFF Drives

HPE 1TB SATA 6G Business Critical 7.2K SFF BC 1-year Warranty HDD	P28610-B21
HPE 2TB SATA 6G Business Critical 7.2K SFF BC 1-year Warranty 512e HDD	P28500-B21

#### Midline - 6G SATA - LFF Drives

HPE 2TB SATA 6G Business Critical 7.2K LFF LP 1-year Warranty Multi Vendor HDD	861681-B21
HPE 4TB SATA 6G Business Critical 7.2K LFF LP 1-year Warranty Multi Vendor HDD	861683-B21
HPE 1TB SATA 6G Business Critical 7.2K LFF LP 1-year Warranty Multi Vendor HDD	861686-B21
HPE 12TB SATA 6G Business Critical 7.2K LFF LP 1-year Warranty Helium 512e Multi Vendor HDD	881787-B21
HPE 14TB SATA 6G Business Critical 7.2K LFF LP 1-year Warranty Helium 512e Multi Vendor HDD	P09165-B21
HPE 8TB SATA 6G Business Critical 7.2K LFF LP 1-year Warranty 512e Multi Vendor HDD	834028-B21
HPE 6TB SATA 6G Business Critical 7.2K LFF LP 1-year Warranty 512e Multi Vendor HDD	861742-B21
HPE 16TB SATA 6G Business Critical 7.2K LFF LP 1-year Warranty Helium 512e ISE Multi Vendor HDD	P23449-B21
HPE 18TB SATA 6G Business Critical 7.2K LFF LP 1-year Warranty Helium 512e ISE Multi Vendor HDD	P37678-B21
HPE 10TB SATA 6G Business Critical 7.2K LFF LP 1-year Warranty 512e ISE Multi Vendor HDD	P53557-B21



## Core Options

HPE 20TB SATA 6G Business Critical 7.2K LFF LP 1-year Warranty Helium 512e ISE Multi Vendor HDD P53554-B21

### SED (Self-Encryption Drive)

HPE 2.4TB SAS 12G Mission Critical 10K SFF BC 3-year Warranty 512e Self-encrypting FIPS HDD P28618-B21

HPE 1.2TB SAS 12G Mission Critical 10K SFF BC 3-year Warranty Self-encrypting FIPS HDD P28622-B21

### Optical Drives

HPE 9.5mm SATA DVD-ROM Optical Drive 726536-B21

HPE 9.5mm SATA DVD-RW Optical Drive 726537-B21

HPE Mobile USB DVD-RW Optical Drive 701498-B21

HPE ProLiant DL3XX Gen11 LFF ODD/Display Port Enablement Kit P52150-B21

HPE ProLiant DL345 Gen11 ODD Cable Kit P59602-B21

#### Notes:

- If the optical drive is selected along with 8 LFF CTO server (P54204-B21) then LFF ODD/DP Enablement Kit (P52150-B21) and ODD Cable Kit (P59602-B21) must be selected.
- If the optical drive is selected along with 8 LFF CTO server (P54204-B21) then 4LFF x1 SAS/SATA 12G Front Backplane Kit (P57114-B21) cannot be selected.
- If the optical drive is selected along with the 8SFF CTO server (P54205-B21) then the Universal Media Bay Kit (P57857-B21) and ODD cable kit (P59602-B21) must be selected.
- If the optical drive is selected along with the 8SFF CTO server (P54205-B21), then the 8SFF x4 drive cage (P57109-B21) and 8SFF x4 direct attach cable kit (P57124-B21) cannot be selected.

## Boot Controllers

HPE NS204i-u Gen11 NVMe Hot Plug Boot Optimized Storage Device P48183-B21

#### Notes:

- RAID 1 is preconfigured on the NS204i-u boot device and NO additional RAID can be applied.
- There are two locations to support NS204i-u hot plug boot device on DL345 Gen11 server
  - o Above the power supplies unit slot2 location
  - o Secondary Riser slot6 with 4LFF rear drive cage and low profile riser kit.
- If this NS204i-u boot device is selected then the NS204i-u Cable Kit (P57013-B21) must be selected.
- If this NS204i-u boot device is selected along with the 4LFF rear drive cage (P57113-B21), then the Low Profile Riser kit (P59260-B21) must be selected.
- For additional information, please visit [HPE OS Boot Device QuickSpecs](#)

HPE ProLiant DL3X5 Gen11 NS204i-u NVMe Hot Plug Boot Device Cable Kit P57013-B21

## Risers

#### Notes:

- The riser shipping default in all CTO server are two (2) PCIe Gen5 x16 FH HL. One at the primary riser slot 3 and another at the secondary riser slot 6.
- Maximum one (1) 4PCIe enablement kit (P57116-B21) or 6PCIe enablement kit (P5117-B21) is allowed.

HPE ProLiant DL345 Gen11 4 PCIe x16 Enablement Kit P57116-B21

#### Notes:

- Supports four (4) PCIe Gen5 x16 risers. Three (3) at the primary riser slot 1/2/3 and one (1) at the secondary riser slot 6.
- if 4LFF rear drive cage (P57113-B21) is selected then 4 PCIe x16 enablement kit cannot be selected.
- Cannot be selected with the EDSFF CTO server.



## Core Options

HPE ProLiant DL345 Gen11 6 PCIe x16 Enablement Kit

P57117-B21

**Notes:**

- Supports Six (6) PCIe Gen5 x16 risers. Three (3) at the primary riser slot 1/2/3 and three (3) at the secondary riser slot 4/5/6.
- if 4LFF rear drive cage (P57113-B21) is selected then 6 PCIe x16 enablement kit cannot be selected.
- Cannot be selected with the EDSFF CTO server.

HPE ProLiant DL385 Gen11 x16 Primary FIO Riser Kit for LFF Rear Cage

P55098-B21

**Notes:**

- Supports one (1) PCIe Gen5 x16 risers at the primary riser slot 3 or Secondary riser slot 6.
- Max = 2
- Requires 4LFF rear drive cage (P57113-B21).

HPE ProLiant DL385 Gen11 x16 Low Profile Secondary Riser Kit

P59260-B21

**Notes:**

- Supports one (1) PCIe Gen5 x16 risers at the Secondary riser slot 6.
- Max = 1
- Requires 4LFF rear drive cage (P57113-B21) and NS204i-u boot device (P48183-B21).

HPE ProLiant DL345 Gen11 2 GPU Front FIO Enablement Kit

P55068-B21

**Notes:**

- Supports two (2) PCIe Gen5 x16 risers at the front cage of GPU CTO server.
- Must be selected with GPU CTO server (P54208-B21)
- Max = 1
- This is a factory integrated only option.

Description	Riser position - Primary			Riser position - Secondary			Total Slots	Bus width
	Slot 1	Slot 2	Slot 3	Slot 4	Slot 5	Slot 6		
Default Riser	N/A	N/A	D		N/A	N/A	D	2 FHHL X16
HPE ProLiant DL345 Gen11 4 PCIe x16 Enablement Kit	O	O	D		N/A	N/A	D	4 FHHL X16
HPE ProLiant DL345 Gen11 6 PCIe x16 Enablement Kit	O	O	D	O	O		D	6 FHHL X16
HPE ProLiant DL3x5 Gen11 x16 Primary FIO Riser Kit for LFF Rear Cage	N/A	N/A	O		N/A	N/A	O	1 or 2 FHHL X16
HPE ProLiant DL3x5 Gen11 x16 Low Profile Secondary Riser Kit	N/A	N/A	N/A		N/A	N/A	O	1 HHHL X16

**Notes:** D = Default on server; O = Optional; N/A = not supported or slot/connector not present.



## Core Options

### HPE Networking

#### Notes:

- Requires Performance Fan kit for 100/200 Gigabit Ethernet Adapters or InfiniBand adapters.
- Direct Attach Cable (DAC) for copper environments or fiber transceivers and cables for fiber-optic environments must be purchased separately. Please see the related NIC QuickSpecs for Technical Specifications and additional information:

<https://www.hpe.com/psnow/doc/A00002507ENW>

#### PCIe Adapters

##### 1 Gigabit Ethernet adapters

Intel I350-T4 Ethernet 1Gb 4-port BASE-T Adapter for HPE P21106-B21

Broadcom BCM5719 Ethernet 1Gb 4-port BASE-T Adapter for HPE P51178-B21

##### 10 Gigabit Ethernet adapters

Broadcom BCM57416 Ethernet 10Gb 2-port BASE-T Adapter for HPE P26253-B21

Broadcom BCM57412 Ethernet 10Gb 2-port SFP+ Adapter for HPE P26259-B21

##### 10/25 Gigabit Ethernet adapters

Broadcom BCM57414 Ethernet 10/25Gb 2-port SFP28 Adapter for HPE P26262-B21

Broadcom BCM57504 Ethernet 10/25Gb 4-port SFP28 Adapter for HPE P26264-B21

Intel E810-XXVDA2 Ethernet 10/25Gb 2-port SFP28 Adapter for HPE P08443-B21

Mellanox MCX631102AS-ADAT Ethernet 10/25Gb 2-port SFP28 Adapter for HPE P42044-B21

Intel E810-XXVDA4 Ethernet 10/25Gb 4-port SFP28 Adapter for HPE P08458-B21

##### 100/200 Gigabit Ethernet adapters

#### Notes:

- Requires Performance Fan kit (P58465-B21).
- Max = 3 if with 4 PCIe enablement kit (P57116-B21).
- Max = 5 if with 6 PCIe enablement kit (P57117-B21).

Mellanox MCX623106AS-CDAT Ethernet 100Gb 2-port QSFP56 Adapter for HPE P25960-B21

Intel E810-CQDA2 Ethernet 100Gb 2-port QSFP28 Adapter for HPE P21112-B21

Mellanox MCX623105AS-VDAT Ethernet 200Gb 1-port QSFP56 Adapter for HPE P10180-B21

##### 100 Gigabit Storage Offload Adapter

**Notes:** Requires Performance Fan kit (P58465-B21).

HPE NV60100M 100Gb 2-port Storage Offload Adapter R8M41A

##### 200/400 Gigabit Slingshot Adapters

HPE Slingshot SA210S Ethernet 200Gb 1-port PCIe NIC R4K46A

#### Notes:

- Can only be selected or configured for a Cray or Slingshot Solution. Not allowed for a Non-Cray or Non-Slingshot Solution
- Cannot have the following networking options configured within the same server: Slingshot 11 or Slingshot 22.

### OCP 3.0 Adapters

##### 1 Gigabit Ethernet OCP adapters

Intel I350-T4 Ethernet 1Gb 4-port BASE-T OCP3 Adapter for HPE P08449-B21

Broadcom BCM5719 Ethernet 1Gb 4-port BASE-T OCP3 Adapter for HPE P51181-B21

##### 10 Gigabit Ethernet OCP Adapters

Broadcom BCM57412 Ethernet 10Gb 2-port SFP+ OCP3 Adapter for HPE P26256-B21

Broadcom BCM57416 Ethernet 10Gb 2-port BASE-T OCP3 Adapter for HPE P10097-B21



## Core Options

### 10/25 Gigabit Ethernet OCP adapters

Broadcom BCM57414 Ethernet 10/25Gb 2-port SFP28 OCP3 Adapter for HPE	P10115-B21
Broadcom BCM57504 Ethernet 10/25Gb 4-port SFP28 OCP3 Adapter for HPE	P26269-B21
Intel E810-XXVDA2 Ethernet 10/25Gb 2-port SFP28 OCP3 Adapter for HPE	P10106-B21
Mellanox MCX631432AS-ADAI Ethernet 10/25Gb 2-port SFP28 OCP3 Adapter for HPE	P42041-B21

### 100/200 Gigabit Ethernet adapters

#### Notes:

- Requires OCP1 upgrade cable kit (P56658-B21) to support PCIe Gen5 x16 bandwidth on OCP21 slot
- Requires Performance Fan kit (P58465-B21).

Intel E810-CQDA2 Ethernet 100Gb 2-port QSFP28 OCP3 Adapter for HPE	P22767-B21
--	------------

## HPE InfiniBand

#### Notes:

- Requires Performance Fan kit (P58465-B21) and subject to the recommended system ambient temperature.
- Requires OCP upgrade cable kit (P56658-B21) for 200Gb OCP adapters (P31323-B21 or P31348-B21)
- For more information, please visit: [HPE InfiniBand Options for HPE ProLiant and Apollo Servers](#)

HPE InfiniBand HDR100/Ethernet 100Gb 1-port QSFP56 PCIe4 x16 MCX653105A-ECAT Adapter	P23665-B21
HPE InfiniBand HDR100/Ethernet 100Gb 2-port QSFP56 PCIe4 x16 MCX653106A-ECAT Adapter	P23666-B21
HPE InfiniBand HDR/Ethernet 200Gb 1-port QSFP56 PCIe4 x16 MCX653105A-HDAT Adapter	P23664-B21
HPE InfiniBand HDR/Ethernet 200Gb 2-port QSFP56 PCIe4 x16 MCX653106A-HDAT Adapter	P31324-B21
HPE InfiniBand HDR/Ethernet 200Gb 1-port QSFP56 PCIe4 x16 OCP3 MCX653435A-HDAI Adapter	P31323-B21
HPE InfiniBand HDR/Ethernet 200Gb 2-port QSFP56 PCIe4 x16 OCP3 MCX653436A-HDAI Adapter	P31348-B21
HPE InfiniBand NDR 1-port OSFP PCIe5 x16 MCX75310AAS-NEAT Adapter	P45641-B21
HPE InfiniBand NDR200 1-port OSFP PCIe5 x16 MCX75310AAS-HEAT Adapter	P45642-B21

## Recommended System Ambient Temperature – PCIe Networking

Category	P/N	Description	SFF/LFF/EDSFF/GPU Servers					
			Slot1	Slot2	Slot3	Slot4	Slot5	Slot6
Networking	P08458-B21	INT E810 10/25GbE 4p SFP28 Adptr					Std fan: 25C	Std fan: 25C
Networking	P25960-B21	MLX MCX623106AS 100GbE 2p QSFP56	25C			25C	25C	Not support
Networking	P21112-B21	INT E810 100GbE 2p QSFP28 Adptr						Not support
Networking	P10180-B21	MLX MCX623105AS 200GbE 1p QSFP56	25C			25C	25C	Not support
Networking	R8M41A	HPE NV60100M 100Gb 2p Strg Offload	25C			25C	25C	Not support
InfiniBand	P23665-B21	HPE IB HDR100/EN 100Gb 1p QSFP56						Not support
InfiniBand	P23666-B21	HPE IB HDR100/EN 100Gb 2p QSFP56	25C			25C	25C	Not support
InfiniBand	P23664-B21	HPE IB HDR/EN 200Gb 1p QSFP56 Adptr	25C			25C	25C	Not support
InfiniBand	P31324-B21	HPE IB HDR/EN 200Gb 2p QSFP56 Adptr	25C			25C	25C	Not support
InfiniBand	P45641-B21	HPE IB NDR 1p OSFP MCX75310AAS Adptr	25C			25C	25C	Not support
InfiniBand	P45642-B21	HPE IB NDR200 1p OSFP MCX75310AAS	25C			25C	25C	Not support



## Core Options

### Suggested System Ambient Temperature – OCP Networking

Category	P/N	Description	SFF/LFF/EDSFF/GPU Server	
			OCP21	OCP22
Networking	P26269-B21	BCM 57504 10/25GbE 4p SFP28 OCP3 Adptr		Std fan: 25C
Networking	P22767-B21	INT E810 100GbE 2p QSFP28 OCP3 Adptr		Not support
InfiniBand	P31323-B21	HPE IB HDR/EN 200Gb 1p QSFP56 OCP3 Adptr	25C	Not support
InfiniBand	P31348-B21	HPE IB HDR/EN 200Gb 2p QSFP56 OCP3 Adptr	25C	Not support

#### Notes

- Blank = no limitation
- Not support = configuration not allowed because of thermal limitation.

### Accelerators

NVIDIA L4 24GB PCIe Accelerator for HPE

S0K89C

#### Notes:

- This is a PCIe Gen4 x 16 single-width HDDL GPU card.
- Max = 2
- This GPU can only be selected with GPU CTO Server.

### HPE Storage Options

#### Emulex Fibre Channel HBAs

HPE SN1610E 32Gb 1-port Fibre Channel Host Bus Adapter

R2J62A

HPE SN1610E 32Gb 2-port Fibre Channel Host Bus Adapter

R2J63A

HPE SN1700E 64Gb 1-port Fibre Channel Host Bus Adapter

R7N77A

HPE SN1700E 64Gb 2-port Fibre Channel Host Bus Adapter

R7N78A

#### QLogic Fibre Channel HBAs

HPE SN1610Q 32Gb 1-port Fibre Channel Host Bus Adapter

R2E08A

HPE SN1610Q 32Gb 2-port Fibre Channel Host Bus Adapter

R2E09A

### Power and Cooling

#### Cooling

HPE ProLiant DL3X5 Gen11 CPU Performance 1U Heat Sink Kit

P58457-B21

HPE ProLiant DL3X5 Gen11 Standard 2U Heat Sink Kit

P58458-B21

HPE ProLiant DL3X5 Gen11 Performance 2U Heat Sink Kit

P58459-B21

#### Notes:

- If processor upto 240W is selected, then Standard Heat Sink (P58458-B21) and Standard Fan Kit (P58464-B21) must be selected.
- If processor more than or equal to 260W is selected, then Performance Heat Sink (P58459-B21) and Performance Fan Kit (P58465-B21) must be selected.
- If processor less than or equal to 300W is selected along with 4LFF or 8SFF mid tray drive cage, then 1U Performance Heat Sink (P58457-B21) and Performance Fan Kit (P58465-B21) must be selected.

HPE ProLiant DL3X5 Gen11 2U Standard Fan Kit

P58464-B21



**Core Options**

HPE ProLiant DL3X5 Gen11 2U Performance Fan Kit

P58465-B21

**Notes:** Performance Fan Kit (P58462-B21) must be selected if any of the below options are selected

- GPU CTO server (P54208-B21)
- 8SFF/4LFF Midtray drive cage (P57108-B21, P57109-B21, P57112-B21) or Rear drive cage (P57110-B21, P57113-B21)
- 100/200GB network adapters or InfiniBand network adapters

Front Drive Bay	Mid Tray	Cooling options summary			
		Rear	CPU cTDP	Heat Sink	Fan Kit
up to 12LFF/ 24SFF/ 36EDSFF			<=240W	Standard	Std Fan
			>240W	Performance	Std Fan
		4LFF or 2SFF	<=240W	Standard	Perf fan
		4LFF or 2SFF	>240W	Performance	Perf fan
GPU CTO server	4LFF or 8SFF	Any	<=300W	1U Performance	Perf fan
			<=240W	Standard	Perf fan
			>240W	Performance	Perf fan

**Power Supplies**

HPE Flexible Slot (Flex Slot) Power Supplies share a common electrical and physical design that allows for hot plug, and tool-less installation into HPE ProLiant Servers. Flex Slot power supplies are certified for high-efficiency operation and offer multiple power output options, allowing users to "right-size" a power supply for specific server configurations. This flexibility helps to reduce power waste, lower overall energy costs, and avoid "trapped" power capacity in the data center.

**Notes:**

- Select a minimum (1), maximum (2) power supplies
- All power supplies in a server should match. Mixing Power Supplies is not supported.
- 1600W Power supplies only support high line voltage (200VAC to 240VAC).
- Before making a power supply selection it is highly recommended that the HPE Power Advisor is run to determine the right size power supply for your server configuration. The HPE Power Advisor is located at: <https://poweradvisorext.it.hpe.com/?Page=Index>
- HPE ProLiant servers ship with an IEC-IEC power cord used for rack mounting with Power Distribution Units (PDUs). Visit [HPE Power Cords and Cables](#) for a full list of optional power cords

HPE 500W Flex Slot Platinum Hot Plug Low Halogen Power Supply Kit

865408-B21

HPE 800W Flex Slot Platinum Hot Plug Low Halogen Power Supply Kit

P38995-B21

HPE 1000W Flex Slot Titanium Hot Plug Power Supply Kit

P03178-B21

HPE 1600W Flex Slot -48VDC Hot Plug Power Supply Kit

P17023-B21

HPE 1600W Flex Slot Platinum Hot Plug Low Halogen Power Supply Kit

P38997-B21

HPE 1800W-2200W Flex Slot Titanium Hot Plug Power Supply Kit

P44712-B21

HPE 1600W -48VDC Power Cable Lug Kit

P36877-B21

**Notes:** Must be selected along with HPE 1600W Flex Slot -48VDC Hot Plug Power Supply Kit (P17023-B21)



## Core Options

### HPE Security

HPE Trusted Supply Chain for HPE ProLiant

P36394-B21

**Notes:**

- HPE Trusted Supply Chain is an optional security upgrade intended for agencies and regulated industries needing enhanced security and compliance needs. Applying this option to a DL345 Gen11 CTO server ensures it is built in the USA in a secured facility by vetted HPE personnel assigned to the manufacturing processes. A multitude of checkpoints/inspections for malicious microcode and counterfeit parts are performed throughout the server build, and additional safeguards are put in place against cyber-exploits throughout the server lifecycle. Learn more at <http://www.hpe.com/security>
- This option requires the selection of HPE Gen11 Intrusion Detection Kit (P48922-B21)
- This option requires the selection of either HPE iLO Advanced 1-server License with 3yr Support on iLO Licensed Features (BD505A) or HPE iLO Advanced 1-server License with 1yr Support on iLO Licensed Features (512485-B21)
- This option is limited to stand-alone DL345Gen11 CTO servers only. The HPE Trusted Supply Chain configuration will not be available if the server is ordered as factory integrated into a rack
- One instance of the following Electronic License to Use is required per order (not per server): R6X85AAE (HPE Trusted Supply Chain E-LTU)
- This option cannot be selected with TAA instruction SKU or TAA CTO Models.

HPE ProLiant DL385 Gen11 Intrusion Cable Kit

P55713-B21

**Notes:** This provides a physical connection from the chassis board and hood and detects any physical intrusion into the chassis, providing security during the entire supply chain process of shipping, receiving distribution, and operation.

HPE Bezel Lock Kit

875519-B21

**Notes:** The Bezel lock kit (875519-B21) must be selected along with the bezel kit (P50400-B21).

HPE Gen11 2U Bezel Kit

P50400-B21

HPE iLO Common Password FIO Setting

P08040-B21

**Notes:**

- Replaces iLO default randomized password by an HPE defined common password. HPE highly recommends changing this password immediately after the initial onboarding process.
- Customers who want to choose their own custom iLO default password should use the HPE Factory Express Integration Services

### Additional Cable Options

HPE ProLiant DL3X5 Gen11 OCP1 Upgrade Cable Kit

P56658-B21

**Notes:** Supports PCIe x16 bandwidth at OCP slot 21. Required if one of the following options is in the order

- OCP InfiniBand network adapters (P31323-B21, P31348-B21)
- BCM 57504 10/25GbE 4p SFP28 Adaptor (P26269-B21)
- Intel E810 100GbE 2p QSFP28 OCP3 Adptr (P22767-B21)

HPE ProLiant DL3X5 Serial Port Enablement Kit

P50887-B21

**Notes:** This cable kit supports an optional serial port at the rear of the server.

## Software as a Service Management

### HPE GreenLake for Compute Ops Management

**Base SKU**

HPE GreenLake for Compute Ops Management Enhanced 3-year Upfront ProLiant SaaS

R7A11AAE

**Upgrade SKUS**

HPE GreenLake for Compute Ops Management Enhanced 1-year Upfront ProLiant SaaS

R7A10AAE



## Core Options

HPE GreenLake for Compute Ops Management Enhanced 5-year Upfront ProLiant SaaS

R7A12AAE

### HPE OneView

HPE OneView including 3yr 24x7 Support Flexible Quantity E-LTU

E5Y35AAE

HPE OneView w/o iLO including 3yr 24x7 Support Flexible Quantity E-LTU

P8B26AAE

**Notes:** For customers purchasing HPE GreenLake for Compute Ops Management, without a hardware purchase or a BTO purchase, use this base SKU within the ASQ order:

HPE GreenLake for Compute Ops Management Base SaaS

R6Z73AAE

For more information, visit the HPE GreenLake for Compute Ops Management QuickSpecs:

<https://www.hpe.com/psnow/doc/a50004263enw>

Supported Servers – CTO only. No OEM. – Complete list can be found here: Latest Supported Server List:

<https://www.hpe.com/info/com-supported-servers>

# FARTAK SERVICE



## Additional Options

Some options may not be integrated at the factory. To ensure only valid configurations are ordered, Hewlett Packard Enterprise recommends the use of an HPE approved configurator. Contact your local sales representative for additional information.

### Embedded Management

#### HPE iLO Advanced

HPE iLO Advanced Electronic License with 1yr Support on iLO Licensed Features	E6U59ABE
HPE iLO Advanced Electronic License with 3yr Support on iLO Licensed Features	E6U64ABE
HPE iLO for Open Distributed Infrastructure Management 3-year 24x7 LTU	R4H59A
HPE iLO for Open Distributed Infrastructure Management 1-year 24x7 LTU	R4H60A
HPE iLO for Open Distributed Infrastructure Management 3-year 24x7 E-LTU	R4H61AAE
HPE iLO for Open Distributed Infrastructure Management 1-year 24x7 E-LTU	R4H62AAE
HPE iLO for Open Distributed Infrastructure Management 3-year 24x7 AKA Tracking E-LTU	R4H63AAE
HPE iLO for Open Distributed Infrastructure Management 1-year 24x7 AKA Tracking E-LTU	R4H64AAE
HPE iLO Advanced 1-server License with 3yr Support on iLO Licensed Features	BD505A
HPE iLO Advanced Flexible Quantity License with 3yr Support on iLO Licensed Features	BD506A
HPE iLO Advanced AKA Tracking License with 3yr Support on iLO Licensed Features	BD507A
HPE iLO Advanced 1-server License with 1yr Support on iLO Licensed Features	512485-B21
HPE iLO Advanced Flexible Quantity License with 1yr Support on iLO Licensed Features	512486-B21
HPE iLO Advanced AKA Tracking License with 1yr Support on iLO Licensed Features	512487-B21

### Rail Kits

Easy Install rail kits contain telescoping rails which allow for in-rack serviceability. To assist in the installation of the server into the rack an optional installation tool is available by contacting your local services representative.

**Notes:** Hewlett Packard Enterprise recommends that a minimum of two people are required for all Rack Server installations. Please refer to your installation instructions for proper tools and the number of people to use for any installation.

HPE DL3XX Gen11 Easy Install Rail 2 Kit	P52351-B21
---	------------

**Notes:** This Rail kit can be selected with 8LFF/8SFF/24SFF/EDSFF CTO server.

HPE Ball Bearing Rail 8 Kit	P52345-B21
-----------------------------	------------

**Notes:** This Rail kit can be selected with GPU CTO server.

HPE DL38X Gen10 Plus 2U Cable Management Arm for Rail Kit	P22020-B21
---	------------

**Notes:** CMA can be selected only with the Rail kit.

### HPE Tape Backup

- For the complete range of tape drives, autoloaders, libraries, and media see <https://www.hpe.com/us/en/storage/storeever-tape-storage.html>.
- For hardware and software compatibility of Hewlett Packard Enterprise tape backup products <http://www.hpe.com/storage/BURACompatibility>.



## Additional Options

### HPE Racks

- Please see the [HPE Advanced Series Racks QuickSpecs](#) for information on additional rack options and rack specifications.
- Please see the [HPE Enterprise Series Racks QuickSpecs](#) for information on additional rack options and rack specifications.
- Please see the [HPE Standard Series Racks QuickSpecs](#) for information on additional rack options and rack specifications.

### HPE Power Distribution Units (PDUs)

- Please see the [HPE Basic Power Distribution Units \(PDU\) QuickSpecs](#) for information on these products and their specifications.
- Please see the [HPE Metered Power Distribution Units \(PDU\) QuickSpecs](#) for information on these products and their specifications.
- Please see the [HPE Intelligent Power Distribution Unit \(PDU\) QuickSpecs](#) for information on these products and their specifications.
- Please see the [HPE Metered and Switched Power Distribution Units \(PDU\) QuickSpecs](#) for information on these products and their specifications.

### HPE Uninterruptible Power Systems (UPS)

- To learn more, please visit the [HPE Uninterruptible Power Systems \(UPS\) web page](#).
- Please see the [HPE DirectFlow Three Phase Uninterruptible Power System QuickSpecs](#) for information on these products and their specifications.
- Please see the [HPE Line Interactive Single Phase UPS QuickSpecs](#) for information on these products and their specifications.

### HPE Rack Options

- Please see the [HPE KVM Switches web page](#) for information on these products and their specifications

### HPE Support Services

#### HPE Install & Startup ProLiant Entry 300 Series

HPE Install ProLiant DL3xx Service

U4506E

HPE Installation and Startup DL3xx Service

U4507E

#### Tech Care

HPE 3 Year Tech Care Essential DL345 GEN11 Service

H78X5E

HPE 3 Year Tech Care Essential wDMR DL345 GEN11 Service

H78X6E

HPE 5 Year Tech Care Essential DL345 GEN11 Service

H78Z9E

HPE 5 Year Tech Care Essential wDMR DL345 GEN11 Service

H79A0E



## Memory

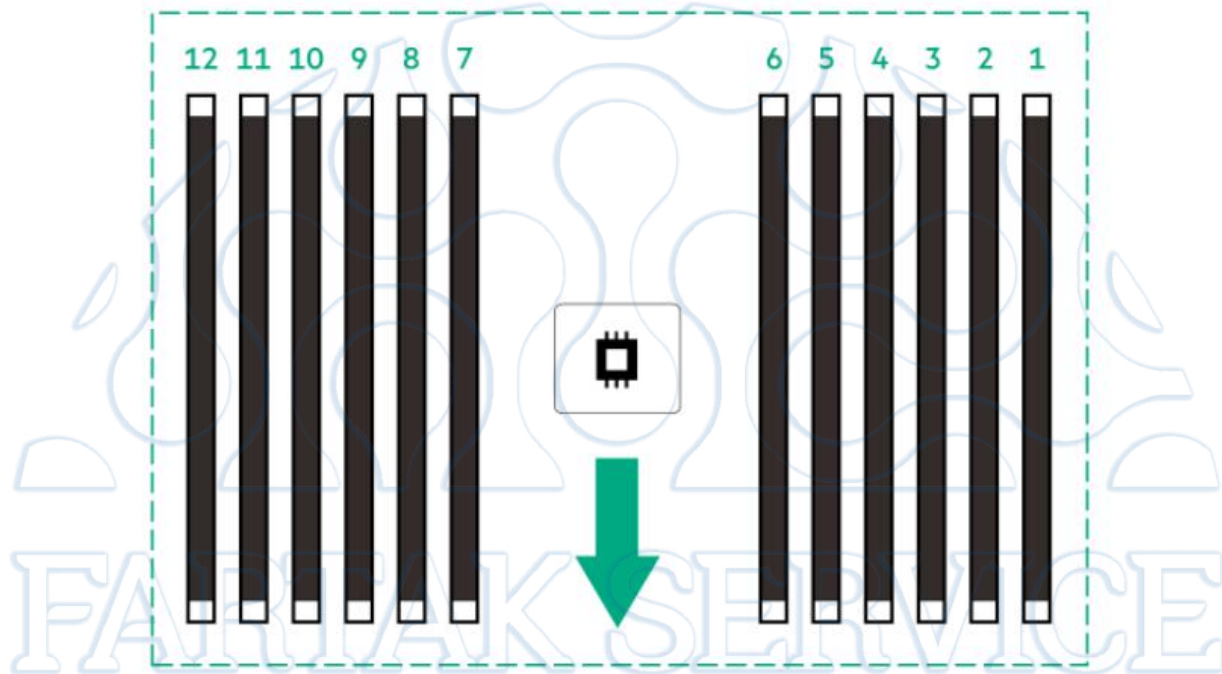

The arrow points to the front of the server

### General Memory Population Rules and Guidelines:

- Install DIMMs only after the corresponding processor is installed.
- To maximize performance, it is recommended to balance the total memory capacity between all installed processors.
- The maximum memory speed is a function of the memory type, memory configuration, and processor model.
- The maximum memory capacity is a function of the number of DIMM slots on the platform, the largest DIMM capacity qualified on the platform, the number and model of installed processors qualified on the platform.
- To realize the performance memory capabilities listed in this document, HPE DDR5 Smart Memory is required. For additional information, please see the: **[HPE DDR5 Smart Memory QuickSpecs](#)**
- For details on the Memory Population Rules and Guidelines with AMD EPYC 9004 series processors, please go to: **<https://www.hpe.com/psnow/doc/a50007481enw>**



Storage

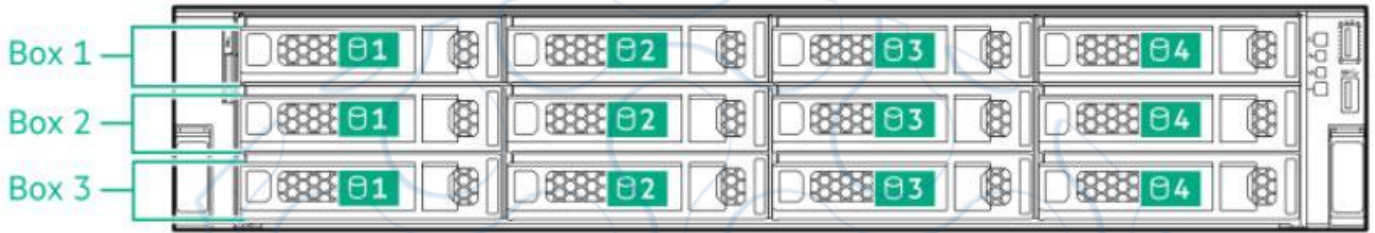

12 LFF Front

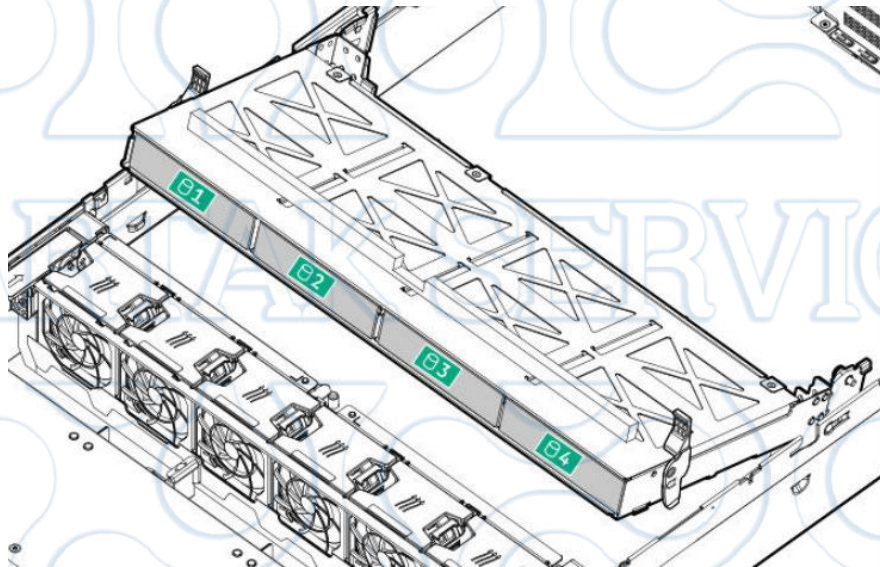

4 LFF Mid Tray

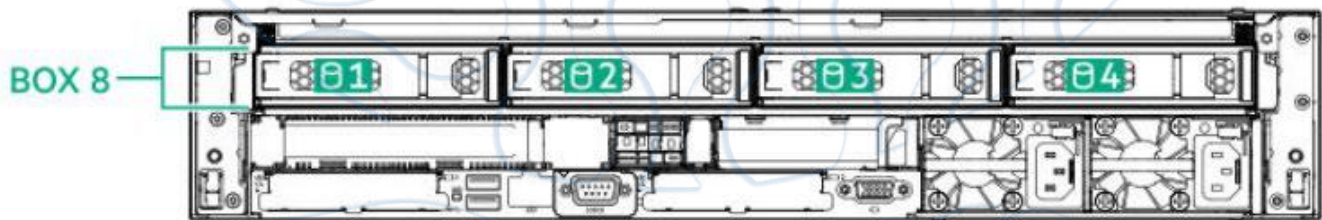

Rear Panel + 4 LFF drives



Storage

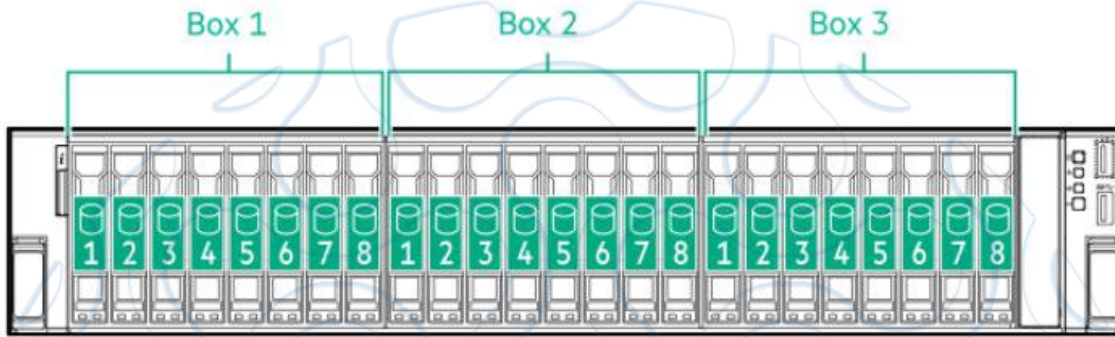

24 SFF Front

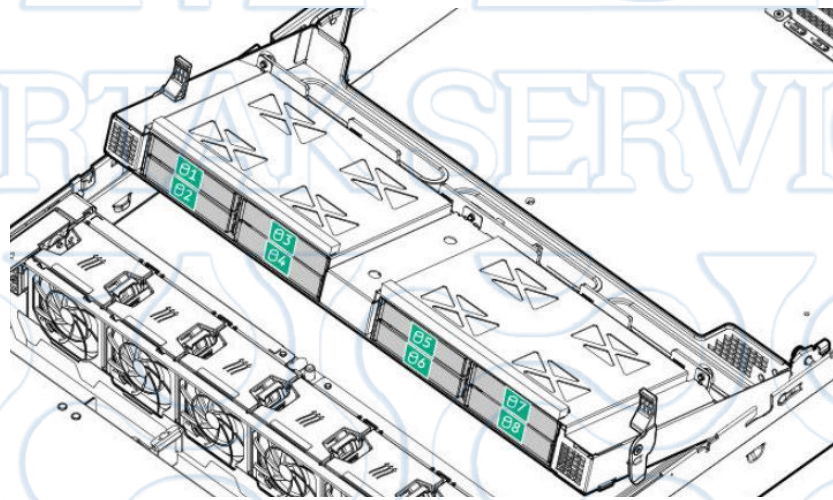

8 SFF Mid Tray

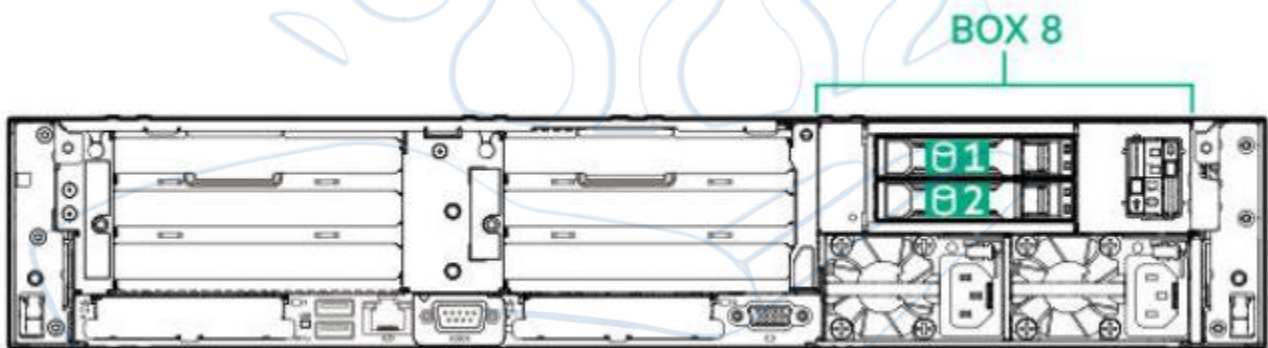

Rear Panel + rear 2 SFF drives



Storage

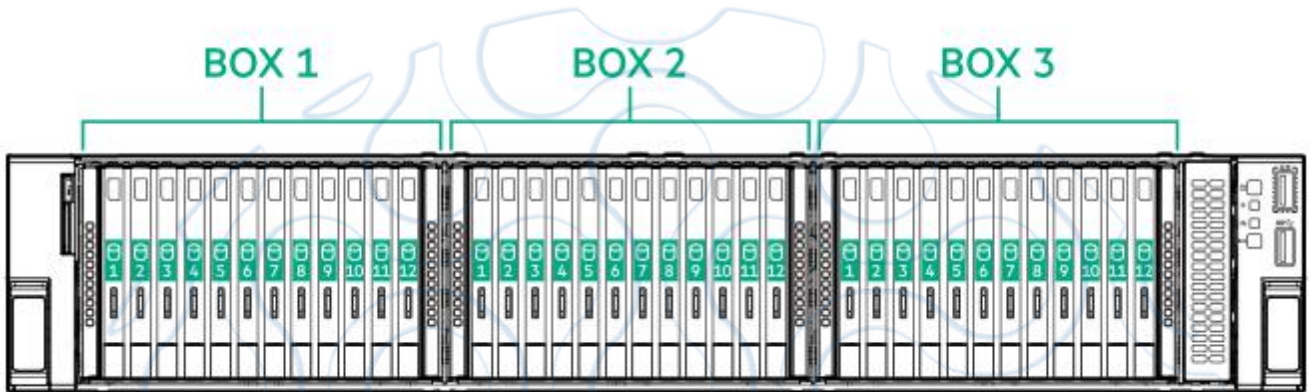

36 EDSFF E3.S 1T Drives

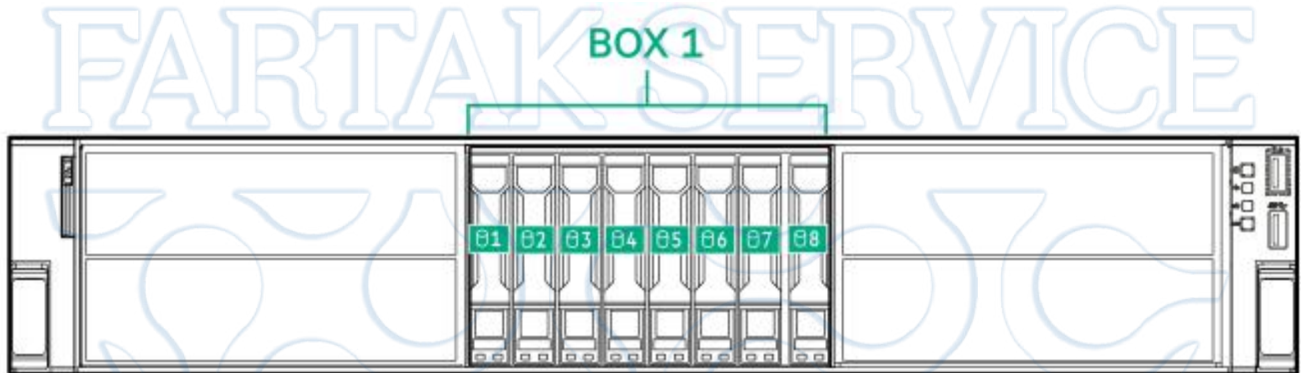

8 SFF Drives in GPU CTO server

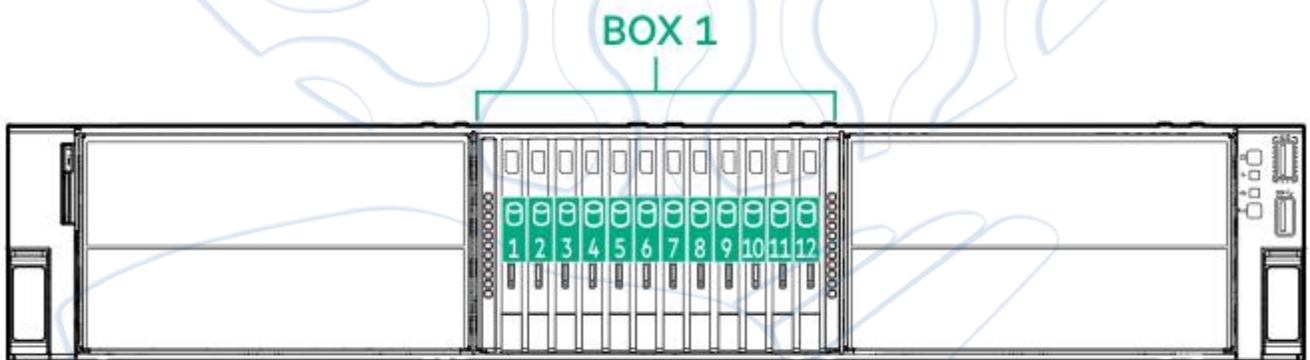

12 EDSFF Drives in GPU CTO server



## Technical Specifications

### System Unit

#### Dimensions (Height x Width x Depth)

- **8SFF, 24SFF and EDSFF chassis**  
8.75 x 44.8 x 64.6 cm  
3.45 x 17.64 x 25.45 in
- **8LFF chassis:**  
8.75 x 44.8 x 66.3 cm  
3.45 x 17.64 x 26.11 in
- **GPU Chassis:**  
8.75 x 44.8 x 79.87 cm  
3.45 x 17.64 x 31.44 in
- **Package:**  
27 x 60 x 91.77 cm  
10.63 x 23.62 x 36.13 in

#### Weight (approximate)

- 8SFF chassis:
  - Minimum: 8 SFF chassis with 0 drives, 1 processor, 1 power supply, 1 standard heatsink, 1 DIMM, 1 Smart Array controller, and 6 standard fans.
    - 16.04 kg
    - 35.36 lb
  - Maximum: 8 SFF chassis with 8 drives (no mid/rear drive), 1 processor, 2 power supply, 1 standard heatsink, 12 DIMM, 1 Smart Array controller, and 6 standard fans.
    - 18.83 kg
    - 41.51 lb
  - Package
    - 4.175kg
    - 9.204 lb
- 8LFF chassis:
  - Minimum: 8 LFF chassis with 0 drives, 1 processor, 1 power supply, 1 standard heatsink, 1 DIMM, 1 Smart Array controller, and 6 standard fans.
    - 16.97 kg
    - 37.41 lb
  - Maximum: 8 LFF chassis with 8 drives (no mid/rear drive), 1 processor, 2 power supply, 1 standard heatsink, 12 DIMM, 1 Smart Array controller, and 6 standard fans.
    - 23.95 kg
    - 52.81 lb
  - Package
    - 4.240 kg
    - 9.347 lb
- EDSFF chassis:
  - Minimum: EDSFF chassis with 1 drives, 1 processor, 1 power supply, 1 standard heatsink, 1 DIMM, and 6 standard fans.
    - 16.13 kg
    - 35.56 lb



## Technical Specifications

- Maximum: EDSFF chassis with 36 drives, 1 processor, 2 power supply, 1 performance heatsink, 12 DIMM, and 6 performance fans.
  - 24.87 kg
  - 54.83 lb
- GPU chassis:
  - Minimum: GPU chassis with 1 single-width accelerator, 1 EDSFF drives, 1 processor, 1 power supply, 1 standard heatsink, 1 DIMM, and 6 standard fans.
    - 16.97 kg
    - 37.41 lb
  - Maximum: GPU chassis with 2 double-width accelerators, 12 EDSFF drives, 1 processor, 2 power supply, 1 performance heatsink, 12 DIMM, and 6 performance fans.
    - 27.12 kg
    - 59.79 lb

### Input Requirements (per power supply)

#### Rated Line Voltage

- 100 to 120 VAC
- 200 to 240 VAC

### BTU Rating

#### Maximum

- For 1600W Power Supply: 5918 BTU/hr (at 200 VAC), 5884 BTU/hr (at 240 VAC) for China
- For 800W Power Supply: 3207 BTU/hr (at 100 VAC), 3071 BTU/hr (at 200 VAC), 3112 BTU/hr (at 240 VAC) for China Only
- For 500W Power Supply: 1979 BTU/hr (at 100 VAC), 1911 BTU/hr (at 200 VAC), 1965 BTU/hr (at 240 VAC) for China Only

### Power Supply Output (per power supply)

#### Rated Steady-State Power

- For 1600W Power Supply: 1600W (at 240 VAC), 1600W (at 240 VAC)
- For 800W Power Supply: 800W (at 100 VAC), 800W (at 240 VAC), 800W (at 240 VAC) input for China only
- For 500W Power Supply: 500W (at 100 VAC), 500W (at 240 VAC), 500W (at 240 VAC) input for China only

#### Maximum Peak Power

- For 1600W Power Supply: 1600W (at 200 to 240 1VAC), 1600W (at 240 VAC) input for China only
- For 800W Power Supply: 800W (at 100 to 127 VAC), 800W (at 200 to 240 1VAC), 800W (at 240 VAC) input for China only
- For 500W Power Supply: 500W (at 100 to 127 VAC), 500W (at 200 to 240 VAC), and 500W (at 240 VAC) input for China only



## Technical Specifications

### System Inlet Temperature

- **Standard Operating Temperature**

10° to 35°C (50° to 95°F) at sea level with an altitude derating of 1.0°C per every 305 m (1.8°F per every 1000 ft) above sea level to a maximum of 3050 m (10,000 ft), no direct sustained sunlight. The maximum rate of change is 20°C/hr (36°F/hr). The upper limit and rate of change may be limited by the type and number of options installed.

System performance during standard operating support may be reduced if operating with a fan fault or above 30°C (86°F).

- **Extended Ambient Operating Temperature**

For approved hardware configurations, the supported system inlet range is extended to be: 5° to 10°C (41° to 50°F) and 35° to 40°C (95° to 104°F) at sea level with an altitude derating of 1.0°C per every 175 m (1.8°F per every 574 ft) above 900 m (2953 ft) to a maximum of 3050 m (10,000 ft). The approved hardware configurations for this system are listed at the URL: <http://www.hpe.com/servers/ashrae>

For approved hardware configurations, the supported system inlet range is extended to be: 40° to 45°C (104° to 113°F) at sea level with an altitude derating of 1.0°C per every 125 m (1.8°F per every 410 ft) above 900 m (2953 ft) to a maximum of 3050 m (10,000 ft). The approved hardware configurations for this system are listed at the URL: <http://www.hpe.com/servers/ashrae>

System performance may be reduced if operating in the extended ambient operating range or with a fan fault.

- **Non-operating**

-30° to 60°C (-22° to 140°F). Maximum rate of change is 20°C/hr (36°F/hr).

---

### Relative Humidity

- **Operating**

8% to 90% - Relative humidity (Rh), 28°C maximum wet bulb temperature, non-condensing.

- **Non-operating** (non-condensing)

5 to 95% relative humidity (Rh), 38.7°C (101.7°F) maximum wet bulb temperature, non-condensing.

---

### Altitude

- **Operating**

3050 m (10,000 ft). This value may be limited by the type and number of options installed. The maximum allowable altitude change rate is 457 m/min (1500 ft/min).

- **Non-operating**

9144 m (30,000 ft). Maximum allowable altitude change rate is 457 m/min (1500 ft/min).

---

### Emissions Classification (EMC) – Regulatory Information

To view the regulatory information for your product, view the Safety and Compliance Information for Server, Storage, Power, Networking, and Rack Products, available at the Hewlett Packard Enterprise Support Center:

<http://www.hpe.com/support/Safety-Compliance-EnterpriseProducts>

---

### Acoustic Noise

Listed are the declared mean A-Weighted sound power levels (LwAm), declared average bystander position A-Weighted sound pressure levels (LpAm), and the statistical adder for verification, Kv, is a quantity to be added to the declared mean A-weighted sound power level, LwA,m when the product is operating in a 23°C ambient environment. Noise emissions were measured in accordance with ISO 7779 (ECMA 74) and declared in accordance with ISO 9296 (ECMA 109). The listed sound levels apply to standard shipping configurations. Additional options may result in increased sound levels. Please have your HPE representative provide information from the HPE EMESC website for further technical details regarding the configurations listed below.



## Technical Specifications

<b>Idle</b>	
LWA,m	5.5 B Base
LpAm	41 dBA Base
Kv	0.4 B Base
<b>Operating</b>	
LWA,m	5.6 B Base
LpAm	42 dBA Base
Kv	0.4 B Base

### Notes:

- The declared mean A-weighted sound power level, LWA,m, is computed as the arithmetic average of the measured.
- A-weighted sound power levels for a randomly selected sample, rounded to the nearest 0,1 B.
- The declared mean A-weighted emission sound pressure level, LpA,m, is computed as the arithmetic average of the measured A-weighted emission sound pressure levels at the bystander positions for a randomly selected sample, rounded to the nearest 1 dB.
- The statistical adder for verification, Kv, is a quantity to be added to the declared mean A-weighted sound power level, LWA,m, such that there will be a 95 % probability of acceptance when using the verification procedures of ISO 9296, if no more than 6,5 % of the batch of new equipment, has A-weighted sound power levels greater than (LWA,m + Kv).
- The quantity, LWA,c (formerly called LWAd), can be computed from the sum of LWA,m, and Kv.
- All measurements made to conform to ISO 7779 / ECMA-74 and declared to conform to ISO 9296 / ECMA-109.
- B, dB, abbreviations for bels and decibels, respectively, where 1 B = 10 dB.
- The results in this declaration apply only to the model numbers listed above when operating and tested according to the indicated modes and standards. A system with additional configuration components or increased operating functionality may increase the noise emission values.
- System under abnormal conditions may increase the noise level, persons in the vicinity of the product [cabinet] for extended periods should consider wearing hearing protection or using other means to reduce noise exposure.

### Environment-friendly Products and Approach - End-of-life Management and Recycling

Hewlett Packard Enterprise offers **end-of-life product return, trade-in, and recycling programs**, in many geographic areas, for our products. Products returned to Hewlett Packard Enterprise will be recycled, recovered, or disposed of in a responsible manner.

The EU WEEE directive (2002/95/EC) requires manufacturers to provide treatment information for each product type for use by treatment facilities. This information (product disassembly instructions) is posted on the Hewlett Packard Enterprise website. These instructions may be used by recyclers and other WEEE treatment facilities as well as Hewlett Packard Enterprise OEM customers who integrate and re-sell Hewlett Packard Enterprise equipment.



## Summary of Changes

Date	Version History	Action	Description of Change
05-Sep-2023	Version 12	Changed	Standard Features, Pre-configured Models, Configuration Information, and Core Options sections were updated.
07-Aug-2023	Version 11	Changed	Overview, Standard Features, Pre-Configured Models, Configuration Information, Core Options, Additional Options, Storage, and Technical Specifications sections were updated
10-Jul-2023	Version 10	Changed	Overview, Standard Features, Service and Support, Pre-Configured Models, Configuration Information, Core Options and Memory sections were updated
13-Jun-2023	Version 9	Changed	Overview, Standard Features, Service and Support, Pre-Configured Models, Configuration Information and Core Options sections were updated
01-May-2023	Version 8	Changed	Standard Features and Core Options sections were updated.
17-Apr-2023	Version 7	Changed	Overview and Core Options sections were updated.
03-Apr-2023	Version 6	Changed	Overview, Standard Features, Service and Support, Pre-configured Models, Configuration Information, Core Options, Additional Options Storage, Memory and Technical Specifications sections were updated.
06-Mar-2023	Version 5	Changed	Overview, Standard Features, Configuration Information, additional Options and Technical Specifications sections were updated.
06-Feb-2023	Version 4	Changed	Overview, Standard Features, Configuration Information, additional Options and Technical Specifications sections were updated.
19-Dec-2022	Version 3	Changed	Standard Features and Configuration information sections were updated.
05-Dec-2022	Version 2	Changed	All sections were updated.
10-Nov-2022	Version 1	New	New QuickSpecs.



## Copyright

Make the right purchase decision.  
Contact our presales specialists.

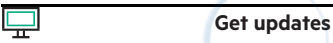
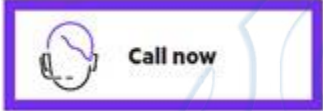

© Copyright 2023 Hewlett Packard Enterprise Development LP. The information contained herein is subject to change without notice. The only warranties for Hewlett Packard Enterprise products and services are set forth in the express warranty statements accompanying such products and services. Nothing herein should be construed as constituting an additional warranty. Hewlett Packard Enterprise shall not be liable for technical or editorial errors or omissions contained herein.

AMD® and EPYC® are registered trademarks of Advanced Micro Devices Corporation in the U.S. and other countries.

Microsoft®, Windows®, and Windows Server® are U.S. registered trademarks of the Microsoft group of companies.

**Hewlett Packard  
Enterprise**

For hard drives, 1GB = 1 billion bytes. Actual formatted capacity is less

a50004298enw - 16902 - Worldwide - V12 - 05-September-2023